

# **OLYMPUS**

## DIGITAL CAMERA

# E-M5 Mark III

## Instruction Manual

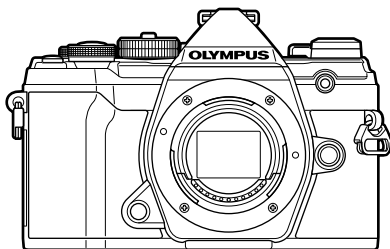

### Table of Contents

#### Feature Index

#### 1. Preparation

#### 2. Shooting

#### 3. Playback

#### 4. Menu functions

#### 5. Connecting the camera to a smartphone

#### 6. Connecting the camera to a computer

#### 7. Cautions

#### 8. Information

#### 9. SAFETY PRECAUTIONS

#### 10. Additions/modifications by firmware update

**Model No. : IM016**

- Thank you for purchasing an Olympus digital camera. Before you start to use your new camera, please read these instructions carefully to enjoy optimum performance and a longer service life.
- Be sure you have read and understood the contents of "9. SAFETY PRECAUTIONS", before using this product. Keep these instructions available for future reference.
- We recommend that you take test shots to get accustomed to your camera before taking important photographs.
- The screen and camera illustrations shown in this manual were produced during the development stages and may differ from the actual product.
- If there are additions and/or modifications of functions due to firmware update for the camera, the contents will differ. For the latest information, please visit the Olympus website.

In addition to the “Instruction Manual”, we also offer a “Camera Function Guide”. Consult these manuals when using the product.



## Instruction Manual (this pdf)

A how-to guide to the camera and its features. The Instruction Manual can be downloaded from the OLYMPUS website or directly using the “OLYMPUS Image Share” (OI.Share) smartphone app.

## Camera Function Guide



A function and setting guide that helps you use camera features to the full. It has been optimized for display on mobile devices and can be viewed using OI.Share.

<https://cs.olympus-imaging.jp/jp/support/cs/webmanual/index.html>



## Indications used in this manual

The following symbols are used throughout this manual.

	Notes and other supplementary information.
	Tips and other helpful information for using the camera.
	References to other pages in this manual.

# Table of Contents

<b>Product Manuals</b>	<b>2</b>	<b>Shooting still pictures</b> ..... <b>34</b>
<b>Before You Begin</b>	<b>9</b>	Shooting with touch screen operations.....36
<b>Feature Index</b>	<b>10</b>	Letting the camera choose aperture and shutter speed ( <b>P</b> : Program AE).....37
<b>Names of parts</b>	<b>14</b>	Choosing aperture ( <b>A</b> : Aperture-Priority AE).....39
<b>1. Preparation</b>	<b>16</b>	Choosing shutter speed ( <b>S</b> : Shutter-Priority AE).....41
■ <b>Unpacking the box contents</b> ..... <b>16</b>		Choosing aperture and shutter speed ( <b>M</b> : Manual Exposure).....43
■ <b>Attaching the Strap</b> ..... <b>17</b>		Long Exposures ( <b>B</b> : Bulb/Time)...45
■ <b>Charging and inserting the battery</b> ..... <b>18</b>		Lighten Blending ( <b>B</b> : Live Composite Photography).....47
■ <b>Inserting the card</b> ..... <b>21</b>		Letting the camera choose the settings (AUTO mode).....49
■ <b>Attaching a lens to the camera</b> ..... <b>23</b>		Shooting in scene mode ( <b>SCN</b> mode).....50
■ <b>Removing Lenses</b> ..... <b>24</b>		Types of scene modes .....51
■ <b>Using the monitor</b> ..... <b>25</b>		Using art filters ( <b>ART</b> mode).....55
■ <b>Turning the camera on</b> ..... <b>26</b>		Custom Mode ( <b>C</b> mode).....57
Sleep Mode .....26		
■ <b>Initial setup</b> ..... <b>27</b>		■ <b>Recording Movies</b> ..... <b>58</b>
■ <b>What to Do If You Can't Read the Display</b> ..... <b>29</b>		Recording movies in photo shooting modes .....58
		Recording movies in movie mode (  ) .....59
<b>2. Shooting</b>	<b>30</b>	Silencing Camera Sounds While Shooting Movies.....61
■ <b>Information displays while shooting</b> ..... <b>30</b>		
■ <b>Switching between displays</b> ..... <b>32</b>		
Switching the information display .....33		

<b>Shooting Settings</b> .....	<b>62</b>	Adjusting color (WB (white balance)).....	<b>83</b>
Direct Buttons.....	63	Making fine adjustments to white balance (WB Compensation).....	<b>85</b>
Controlling exposure (Exposure Compensation).....	64	Reducing camera shake (Image Stabilizer).....	<b>86</b>
Choosing an AF Target Mode (AF Target Mode).....	65	Performing the sequential/ self-timer shooting.....	<b>87</b>
Choosing a Focus Target (AF Target Point).....	66	Setting the image aspect.....	<b>87</b>
Face priority AF/ Eye priority AF.....	67	Photo File and Image Size Options (📷⏪).....	<b>88</b>
Zoom frame AF/Zoom AF (Super Spot AF).....	68	Frame Size, Rate, and Compression (📷⏪).....	<b>89</b>
Changing ISO sensitivity (ISO).....	70	Filming Slow- or Fast-Motion Movies (Slow- and Fast-Motion Movies).....	<b>92</b>
Locking the exposure (AE Lock).....	70	Using a flash (Flash photography).....	<b>93</b>
Performing the sequential/ self-timer shooting.....	71	Choosing a Flash Mode (Flash Mode).....	<b>94</b>
Self-Timer Options (🕒 Custom Self-timer).....	73	Adjusting flash output (Flash intensity control).....	<b>97</b>
Shooting without the vibration caused by shutter button operations (Anti-Shock [📷]).....	73	Processing options (Picture Mode).....	<b>98</b>
Shooting without shutter sound (Silent [🔇]).....	74	Adjusting overall color (Color Creator).....	<b>100</b>
Shooting without a release time lag (Pro Capture shooting).....	74	Making fine adjustments to sharpness (Sharpness).....	<b>101</b>
Shooting still pictures in a higher resolution (High Res Shot).....	76	Making fine adjustments to contrast (Contrast).....	<b>101</b>
The Super Control/LV Super Control Panel.....	77	Making fine adjustments to saturation (Saturation).....	<b>101</b>
Changing ISO sensitivity (ISO).....	80	Making fine adjustments to tone (Gradation).....	<b>102</b>
Choosing a focus mode (AF Mode).....	80	Applying filter effects to monochrome pictures (Color Filter).....	<b>103</b>
Choosing how the camera measures brightness (Metering).....	82		

Adjusting the tone of a monochrome image (Monochrome Color).....	104
Adjusting i-Enhance effects (Effect).....	104
Setting the color reproduction format (Color Space).....	105
Changing the brightness of highlights and shadows (Highlight&Shadow Control) ...	106
Assigning functions to buttons (Button Function).....	107











### 3. Playback 114

<b>Information display during playback</b> .....	<b>114</b>
Playback image information .....	114
Switching the information display .....	115
<b>Viewing photographs and movies</b> .....	<b>116</b>
Finding Pictures Quickly (Index and Calendar Playback).....	117
Zooming In (Playback Zoom) .....	117
Rotating Pictures (Rotate).....	117
Watching movies .....	118
Protecting Pictures (On) .....	118
Deleting Pictures (Erase) .....	119
Selecting Pictures for Sharing (Share Order) .....	119
Selecting Multiple Pictures (On, Erase Selected, Share Order Selected).....	119
Print order (DPOF) .....	120
Adding Audio to Pictures (U).....	122
<b>Playback Using Touch Controls</b> .....	<b>123</b>
Selecting and protecting images.....	124

### 4. Menu functions 125

<b>Basic menu operations</b> .....	<b>125</b>
<b>Using Shooting Menu 1/ Shooting Menu 2</b> .....	<b>127</b>
Restoring Default Settings (Reset).....	127
Saving Settings (Assign to Custom Mode).....	128
Processing options (Picture Mode).....	129
Photo File and Image Size Options (📷⬅️).....	129
Digital Zoom (Digital Tele-converter) .....	130
Shooting automatically with a fixed interval (Time lapse shooting).....	131
Varying settings over a series of photographs (Bracketing).....	132
Taking HDR (High Dynamic Range) images (HDR).....	137
Recording multiple exposures in a single image (Multiple Exposure) .....	139
Keystone correction and perspective control (Keystone Comp.) .....	141
Setting anti-shock/silent shooting (Anti-Shock [♦]/Silent [♥]) .....	142
Setting high resolution shooting (High Res Shot).....	143
Shooting with remote control wireless flash (📡RC Mode).....	143

<b>Using the Video Menu</b> .....	144	<b>Using the custom menus</b> .....	161
Choosing an Exposure Mode (Movie Mode (Movie Exposure Modes)).....	147	<b>A1</b> AF/MF .....	161
Reducing Flicker Under LED Lighting (Flicker Scan).....	148	<b>A2</b> AF/MF .....	162
Frame Size, Rate, and Compression (FPS).....	149	<b>A3</b> AF/MF .....	163
Sound Recording Options (Movie).....	150	<b>A4</b> AF/MF .....	163
Using the Olympus LS-100 IC Recorder.....	151	<b>B</b> Button/Dial/Lever .....	164
<b>Using the Playback Menu</b> .....	153	<b>C1</b> Release/☐/☐/ Image Stabilizer.....	165
Automatically Rotating Portrait- Orientation Pictures for Playback (☐).....	153	<b>C2</b> Release/☐/☐/ Image Stabilizer.....	165
Retouching Pictures (Edit).....	153	<b>D1</b> Disp/☐/☐/PC.....	166
Combining Pictures (Image Overlay).....	155	<b>D2</b> Disp/☐/☐/PC.....	167
Creating Movie Stills (In-Movie Image Capture) .....	156	<b>D3</b> Disp/☐/☐/PC.....	168
Trimming movies (Movie Trimming).....	157	<b>D4</b> Disp/☐/☐/PC.....	168
Removing Protection from All Pictures (Reset Protect) .....	158	<b>E1</b> Exp/ISO/BULB/☐.....	169
Cancelling a share order (Reset share Order) .....	158	<b>E2</b> Exp/ISO/BULB/☐.....	170
<b>Using the setup menu</b> .....	159	<b>E3</b> Exp/ISO/BULB/☐.....	170
Formatting the card (Card Setup).....	160	<b>F</b> ⚡ Custom .....	170
Deleting all images (Card Setup).....	160	<b>G</b> ⚡/WB/Color.....	171
Wireless LAN Options (Wi-Fi/ Bluetooth Settings).....	160	<b>H1</b> Record/Erase.....	172
		<b>H2</b> Record/Erase.....	173
		<b>I</b> EVF.....	173
		<b>J1</b> ☐ Utility.....	174
		<b>J2</b> ☐ Utility.....	174
		Setting Focus and Exposure with the <b>AEL/AFL</b> Button (☐ AEL/AFL) .....	175
		C-AF Tracking Sensitivity (☐ C-AF Sensitivity).....	176
		C-AF Starting Focus Target (☐ C-AF Center Start).....	177
		C-AF Center Target Priority (☐ C-AF Center Priority) .....	178
		Choosing the AF Home Position (☐ Set Home).....	179

Manual Focus Assist (MF Assist) .....	180
Adjusting Focus During Exposures (Bulb/Time Focusing) .....	180
Customizing the Fn Lever (  Fn Lever Function).....	181
Burst Shooting Options (  L Settings/  H Settings) ....	182
Reducing Flicker (Flicker Reduction) .....	184
Choosing the control panel displays (  Control Settings) ...	186
Adding information displays (  /Info Settings).....	188
Choosing the Playback Zoom Ratio (  Default Setting).....	189
Selfie Assist (Selfie Assist) .....	190
Viewing camera images on TV (HDMI).....	191
Live Bulb Update Frequency (Live Bulb) .....	192
Live Time Update Frequency (Live Time).....	192
Choosing the Shutter Speed (Composite Settings).....	193
Reducing Flicker Under LED Lighting (  Flicker Scan) .....	194
Shutter speeds when the flash fires (  X-Sync./  Slow Limit) ....	195
Combinations of JPEG image sizes and compression rates (  Set).....	196
Saving lens info (Lens Info Settings) .....	196
Selecting the display style of the viewfinder (EVF Style).....	197
Correcting Fisheye Distortion (Fisheye Compensation) .....	198

## 5. Connecting the camera to a smartphone 200

- **Adjusting Settings for Connection to a Smartphone .....**201
- **Wireless Settings for When the Camera Is Off.....**202
- **Transferring images to a smartphone.....**203
- **Automatically uploading images while the camera is off.....**204
- **Shooting remotely with a smartphone.....**204
- **Adding position information to images.....**205
- **Resetting Wi-Fi/Bluetooth® settings.....**206
- **Changing the password.....**206
- **Disabling Wi-Fi/Bluetooth® .....**207

## 6. Connecting the camera to a computer 208

- **Connecting the camera to a computer.....**208
- **Copying pictures to a computer.....**208
- **Installing the PC software .....**209

<b>7. Cautions</b>	<b>210</b>
■ <b>Battery and charger</b> .....	<b>210</b>
■ <b>Using your charger abroad</b> .....	<b>211</b>
■ <b>Usable cards</b> .....	<b>211</b>
■ <b>Interchangeable lenses</b> .....	<b>212</b>
■ <b>MF Clutch Lenses</b> .....	<b>213</b>
■ <b>Optional Accessories</b> .....	<b>214</b>
Grip (ECG-5) .....	214
Designated External Flash Units .....	215
Wireless remote control flash photography .....	216
Other external flash units .....	218
■ <b>System chart</b> .....	<b>220</b>
<b>8. Information</b>	<b>222</b>
■ <b>Cleaning and storing the camera</b> .....	<b>222</b>
Cleaning the camera .....	222
Storage.....	222
Cleaning and checking the image pickup device.....	223
Pixel Mapping - Checking the image processing functions.....	223
■ <b>Shooting tips and information</b> .....	<b>224</b>
■ <b>Error codes</b> .....	<b>227</b>
■ <b>Default Settings</b> .....	<b>229</b>
■ <b>Record mode and file size/ number of storable still pictures</b> .....	<b>241</b>
■ <b>Specifications</b> .....	<b>243</b>

<b>9. SAFETY PRECAUTIONS</b>	<b>246</b>
■ <b>SAFETY PRECAUTIONS</b> .....	<b>246</b>
<b>10. Additions/modifications by firmware update</b>	<b>251</b>
<b>Index</b>	<b>252</b>



# Before You Begin

## **Read and Follow Safety Precautions**

To prevent incorrect operation resulting in fire or other damage to property or harm to yourself or to others, read "9. SAFETY PRECAUTIONS" (P. 246) in its entirety before using the camera.

While using the camera, consult this manual to ensure safe and correct operation. Be sure to keep the manual in a safe place once it is read.

Olympus will not be held liable for violations of local regulations arising from use of this product outside the country or region of purchase.

- Use of these features outside the country or region of purchase may violate local wireless regulations; be sure to check with local authorities before use. Olympus will not be held liable for the user's failure to comply with local regulations.

## **Wireless LAN and Bluetooth®**

The camera features built-in wireless LAN and **Bluetooth®**. Use of these features outside the country or region of purchase may violate local wireless regulations; be sure to check with local authorities before use. Olympus will not be held liable for the user's failure to comply with local regulations.

Disable wireless LAN and **Bluetooth®** in areas where their use is prohibited.

 "Disabling Wi-Fi/**Bluetooth®**" (P. 207)











## **■ User Registration**













Visit the OLYMPUS website for information on registering your OLYMPUS products.







# Feature Index













Feature	
Shooting Mode	34
Custom Mode	57
Monitor Display	33, 115
Viewfinder Display	197
Direct Button Functions	63
Live Controls	187
LV Super Control Panel	77, 79
Shooting Menu 1	
Reset / Custom Modes	127
Picture Mode	98, 129
	88, 129
Image Aspect	87
Digital Tele-converter	130
(Drive Mode)	71, 73, 131
Shooting Menu 2	
Bracketing	132
HDR	137
Multiple Exposure	139
Keystone Comp.	141
Anti-Shock []/Silent [	142
High Res Shot	76, 143
RC Mode	216
Video Menu	
Mode Settings	
Mode	147
Flicker Scan	148
Specification Settings	
	149
Noise Filter	144
Picture Mode	144





Feature	
AF/IS Settings	
AF Mode	80
Image Stabilizer	86
Button/Dial/Lever	
Button Function	107
Dial Function	145
Fn Lever Function	145
Shutter Function	145
Elec. Zoom Speed	145
Display Settings	
Control Settings	146
Info Settings	146
Time Code Settings	146
Movie	150
HDMI Output	146
Playback Menu	
	153
Edit	153
Print Order	120
Reset Protect	158
Reset share Order	158
Device Connection	201





Feature	
<b>⚙ Custom Menu</b>	
<b>A1 AF/MF</b>	
 AF Mode	80
 AEL/AFL	175
AF Scanner	161
 C-AF Sensitivity	176
 C-AF Center Start	177
 C-AF Center Priority	178
<b>A2 AF/MF</b>	
[  ] Mode Settings	162
AF Area Pointer	162
AF Targeting Pad	162
[  ] Set Home	179
[  ] Custom Settings	162
<b>A3 AF/MF</b>	
AF Limiter	163
AF Illuminator	163
 Face Priority	67
AF Focus Adj.	163
<b>A4 AF/MF</b>	
Preset MF distance	163
MF Assist	180
MF Clutch	163
Focus Ring	163
Bulb/Time Focusing	180
Reset Lens	163

Feature	
<b>B Button/Dial/Lever</b>	
 Button Function	107
 Function	164
 Dial Function	164
Dial Direction	164
 Fn Lever Function	181
Fn Lever/Power Lever	164
 Elec. Zoom Speed	164
<b>C1 Release/ Image Stabilizer</b>	
S-AF Release Priority	165
C-AF Release Priority	
 L Settings	182
 H Settings	
Flicker Reduction	184
<b>C2 Release/ Image Stabilizer</b>	
 Image Stabilizer	86
 Image Stabilizer	165
Half Way RIs With IS	165
Lens I.S. Priority	165

Feature	
<b>D1</b> Disp/■)/)/PC	
 Control Settings	186
 Info Settings	188, 189
Picture Mode Settings	166
 Settings	166
Multi Function Settings	166
<b>D2</b> Disp/■)/)/PC	
Live View Boost	167
Art LV Mode	167
LV Close Up Settings	167
 Default Setting	189
 Settings	167
<b>D3</b> Disp/■)/)/PC	
Grid Settings	168
Peaking Settings	168
Histogram Settings	188
Mode Guide	168
Selfie Assist	190
<b>D4</b> Disp/■)/)/PC	
■))	168
HDMI	191
USB Mode	168
<b>E1</b> Exp/ISO/BULB/☒	
Exposure Shift	169
EV Step	169
ISO Step	169
ISO-Auto Set	169
ISO-Auto	169
 Noise Filter	169
Noise Reduct.	169

Feature	
<b>E2</b> Exp/ISO/BULB/☒	
Bulb/Time Timer	170
Bulb/Time Monitor	170
Live Bulb	192
Live Time	192
Composite Settings	193
 Flicker Scan	194
<b>E3</b> Exp/ISO/BULB/☒	
Metering	82
AEL Metering	170
[::] Spot Metering	170
<b>F</b>  Custom	
 X-Sync.	195
 Slow Limit	195
 + 	170
 +WB	170
<b>G</b>  /WB/Color	
 Set	88, 129, 196
Pixel Count	88, 129, 196
Shading Comp.	171
WB	83
All 	171
 Keep Warm Color	84
Color Space	105

Feature	
<b>H1</b> Record/Erase	
File Name	172
Edit Filename	172
dpi Settings	172
Copyright Settings	172
Lens Info Settings	196
<b>H2</b> Record/Erase	
Quick Erase	173
RAW+JPEG Erase	173
Priority Set	173
<b>I</b> EVF	
EVF Auto Switch	173
EVF Adjust	173
EVF Style	197
 Info Settings	173
EVF Grid Settings	173
 Half Way Level	173
S-OVF	173
<b>U1</b>  Utility	
Pixel Mapping	223
Press-and-hold Time	174
Level Adjust	174
Touchscreen Settings	174
Menu Recall	174
Fisheye Compensation	198

Feature	
<b>U2</b>  Utility	
Backlit LCD	174
Sleep	174
Auto Power Off	174
Quick Sleep Mode	174
Certification	174
<b>f</b> Setup Menu	
Card Setup	160
	27
	29
	159
Rec View	159
Wi-Fi/Bluetooth Settings	160
Firmware	159

# Names of parts

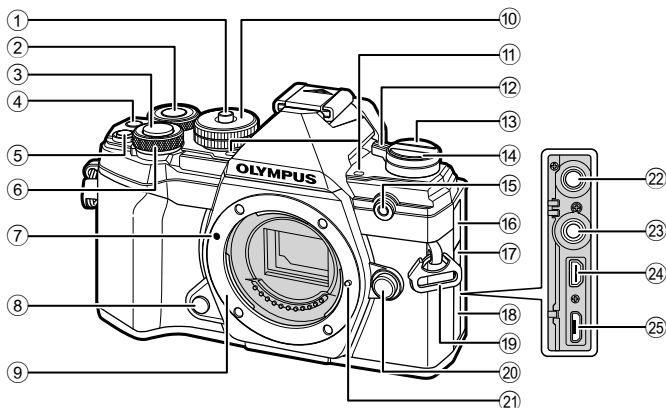

- ① Mode dial lock.....P. 34
- ② Rear dial\* (☺) .....P. 38–43, 113, 116, 189
- ③ Shutter button .....P. 35
- ④ (Movie)/☑ button .....P. 58/P. 119
- ⑤ ☒ (Exposure compensation) button .....P. 38, 40, 42, 44, 64
- ⑥ Front dial\* (☹) .....P. 38–43, 70, 113, 116
- ⑦ Lens attachment mark .....P. 23
- ⑧ Preview button .....P. 108
- ⑨ Mount (Remove the body cap before attaching the lens.)
- ⑩ Mode dial .....P. 34
- ⑪ Stereo microphone .....P. 122, 150
- ⑫ **ON/OFF** lever .....P. 26
- ⑬ **LV** button .....P. 32
- ⑭ (Sequential shooting/Self-timer/HDR) button .....P. 71
- ⑮ Self-timer lamp/AF illuminator .....P. 71/P. 163
- ⑯ Microphone jack cover
- ⑰ Remote cable terminal cover .....P. 219
- ⑱ Connector cover
- ⑲ Strap eyelet.....P. 17
- ⑳ Lens release button .....P. 24
- ㉑ Lens lock pin
- ㉒ Microphone jack (A commercially available microphone can be connected. ø3.5 stereo mini plug).....P. 151
- ㉓ Remote cable terminal.....P. 219
- ㉔ HDMI connector (type D).....P. 191
- ㉕ Micro-USB connector.....P. 151, 208

\* In this manual, the ☹ and ☺ icons represent operations performed using the front dial and rear dial.

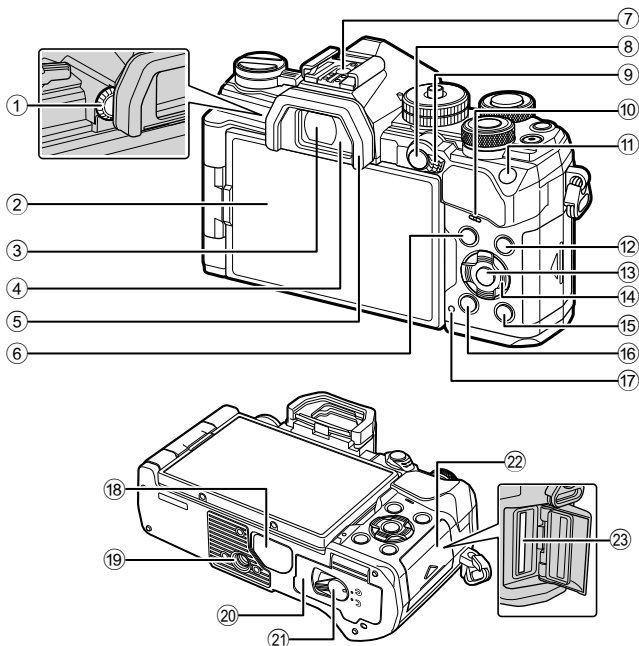

- |   |  |
|---|--|
| ① Diopter adjustment dial.....P. 32                               | ⑫ <b>INFO</b> button.....P. 33, 115            |
| ② Monitor (Touch screen)<br>.....P. 30, 32, 36, 77, 114, 123      | ⑬ <b>OK</b> button.....P. 77, 116, 125         |
| ③ Viewfinder.....P. 32, 197                                       | ⑭ Arrow pad*.....P. 116                        |
| ④ Eye sensor  | ⑮ <b>▶</b> (Playback) button.....P. 116        |
| ⑤ Eyecup.....P. 219   | ⑯ <b>⏏</b> (Erase) button.....P. 119           |
| ⑥ <b>MENU</b> button.....P. 125                                   | ⑰ <b>CHARGE</b> (battery charge) lamp....P. 20 |
| ⑦ Hot shoe.....P. 93, 215   | ⑱ Connector cover.....P. 214                   |
| ⑧ <b>AEL/AFL / O-m</b> (Protect) button<br>.....P. 70, 175/P. 118 | ⑲ Tripod socket                                |
| ⑨ <b>Fn</b> lever.....P. 37–43, 181                               | ⑳ Battery compartment cover.....P. 18          |
| ⑩ Speaker   | ㉑ Battery compartment lock.....P. 18           |
| ⑪ <b>ISO</b> button.....P. 70, 188                                | ㉒ Card compartment cover.....P. 21             |
|   | ㉓ Card slot.....P. 21                          |

\* In this manual, the  $\triangle$   $\nabla$   $\triangleleft$   $\triangleright$  icons represent operations performed using the arrow pad.

## Unpacking the box contents

At purchase, the package contains the camera and the following accessories. If anything is missing or damaged, contact the dealer from whom you purchased the camera.



Camera



Body cap\*



EP-15 eyecup\*



Hot shoe cover\*



Strap

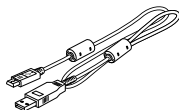

USB cable  
CB-USB12



Flash  
FL-LM3



Lithium-ion battery  
BLS-50

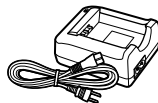

Lithium-ion charger  
BCS-5



Basic Manual

- Warranty Card

\* The body cap, eyecup, and hot shoe cover attached to or inserted in the camera.



## Attaching the Strap

- 1 Before attaching the strap, remove the end from the keeper loop and loosen the strap as shown.

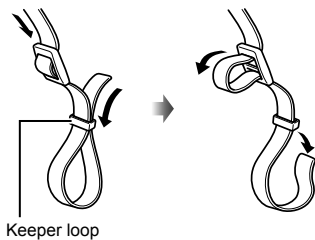

- 2 Pass the end of the strap through the strap eyelet and back through the keeper loop.

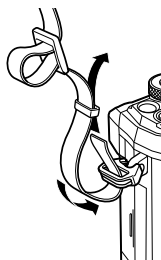

- 3 Pass the end of the strap through the buckle and tighten as shown.

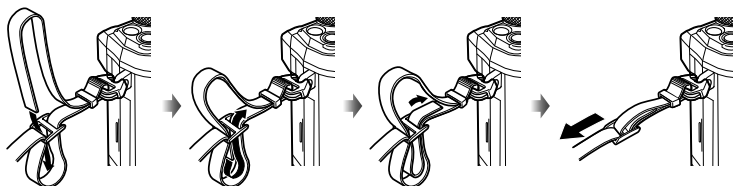

- Attach the other end of the strap to the other eyelet.
- After attaching the strap, pull on it firmly to ensure that it will not come loose.

# Charging and inserting the battery

## 1 Charge the battery.

### Charging indicator

Charging in progress	Lights orange
Charging complete	Off
Charging error	Blinks orange

(Charging time: Approximately 3 hours 30 minutes)

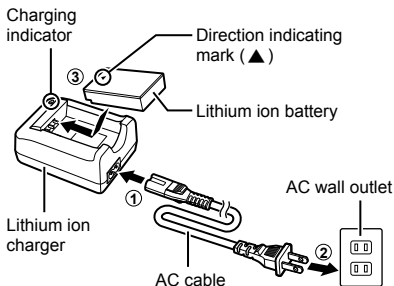

- Unplug the charger when charging is complete.
- Batteries inserted in the camera will charge when the camera is connected to an optional USB-AC adapter.  "On-Board Charging Using an Optional USB-AC Adapter (the F-5AC)" (P. 19)

## 2 Confirm that the **ON/OFF** lever is in the **OFF** position.

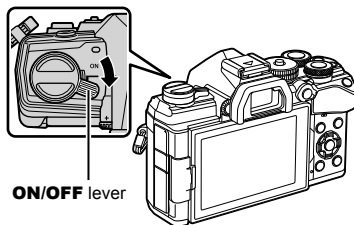

## 3 Open the battery compartment cover.

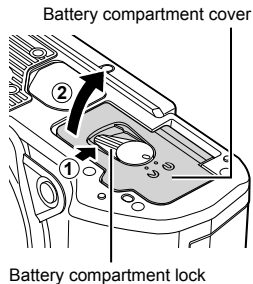

#### 4 Loading the battery.

- Use only BLS-50 batteries (P. 16, 245).

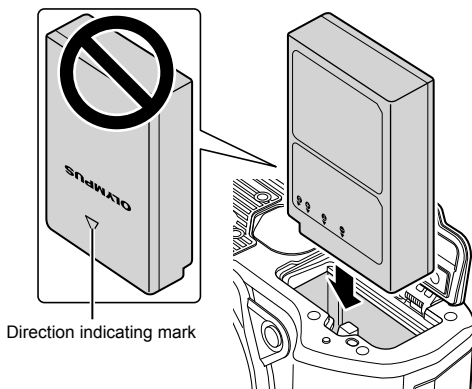

#### 5 Close the battery compartment cover.



- It is recommended to set aside a backup battery for prolonged shooting in case the battery in use drains.
- Also read "Battery and charger" (P. 210).

#### ■ Removing the battery

Turn off the camera before opening or closing the battery compartment cover. To remove the battery, first push the battery lock knob in the direction of the arrow and then remove.

- Contact an authorized distributor or service center if you are unable to remove the battery. Do not use force.
- Never remove batteries or memory cards while the memory card access indicator (P. 31) is displayed.

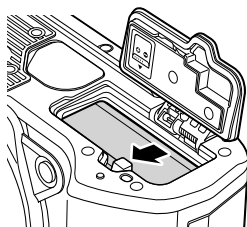

#### ■ On-Board Charging Using an Optional USB-AC Adapter (the F-5AC)

- Read the documentation provided with the F-5AC before use.

#### 1 Confirm that the **ON/OFF** lever is in the **OFF** position.

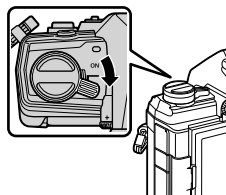

- 2 Confirm that the battery is inserted in the camera.

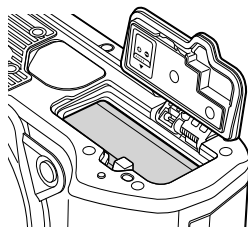

- 3 Connect the camera and USB-AC adapter via USB.

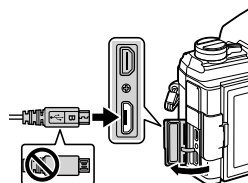

- The **CHARGE** lamp light during charging. Charging takes about 4 hours. The lamp goes out as the batteries reach full charge.

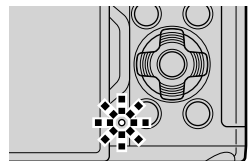

- 4 Charging stops when the camera is turned on.

- The USB-AC adapter cannot be used to charge the batteries when the camera is on.
- If a charging error occurs, the **CHARGE** lamp will blink. Disconnect and reconnect the USB cable.
- USB charging is available when the battery temperature is between 0 and 40 °C.



- The batteries will not charge while the camera is off if pictures are being uploaded to a smartphone via Wi-Fi (background auto upload).  "Automatically uploading images while the camera is off" (P. 204)



#### **The USB-AC Adapter**

- Be sure to unplug the USB-AC adapter for cleaning. Leaving the USB-AC adapter plugged in during cleaning could result in injury or electric shock.

## Inserting the card

The camera uses third-party SD, SDHC, or SDXC memory cards conforming to the SD (Secure Digital) standard. Read “Usable cards” (P. 211) before use.

- 1 Confirm that the **ON/OFF** lever is in the **OFF** position.

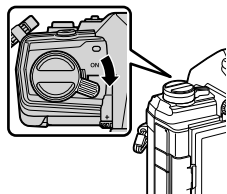

- 2 Open the card compartment cover.

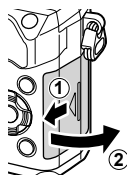

- 3 Slide the card in until it locks into place.
  - Turn off the camera before loading or removing the card.
  - Do not forcibly insert a damaged or deformed card. Doing so may damage the card slot.

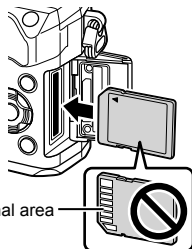

- 4 Close the card compartment cover.
  - Close it securely until you hear it click.
  - Be sure the card compartment cover is closed before using the camera.

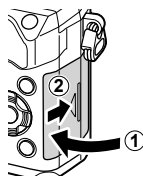

- Cards must be formatted with this camera before first use (P. 160).

**■ Removing the card**

Press the card in to eject it. Pull out the card.

- Never remove batteries or memory cards while the memory card access indicator (P. 31) is displayed.

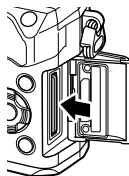

## Attaching a lens to the camera

- 1** Confirm that the **ON/OFF** lever is in the **OFF** position.

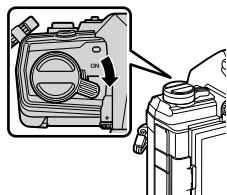

- 2** Remove the rear cap of the lens and the body cap of the camera.

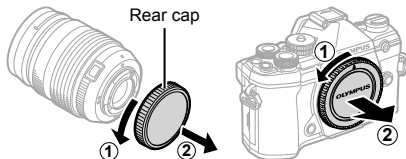

- 3** Align the lens attachment mark (red) on the camera with the alignment mark (red) on the lens, then insert the lens into the camera's body.

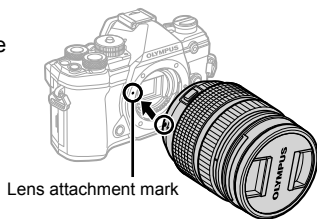

- 4** Rotate the lens clockwise until you hear it click (direction indicated by arrow ③).
- Do not press the lens release button.
  - Do not touch internal portions of the camera.



- 5 Remove the front lens cap.

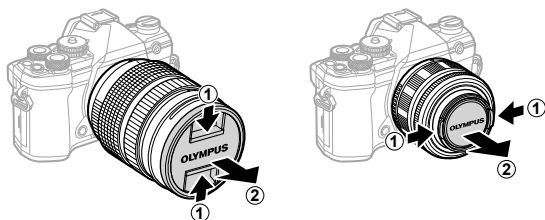

- Before attaching or removing lenses, confirm that the camera **ON/OFF** lever is in the **OFF** position.

## Removing Lenses

- 1 Confirm that the **ON/OFF** lever is in the **OFF** position.

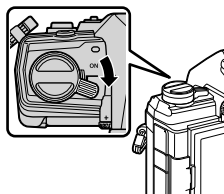

- 2 Hold the lens release button and rotate the lens as shown.

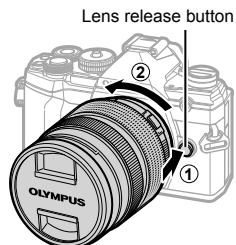

### Interchangeable lenses

Read "Interchangeable lenses" (P. 212).



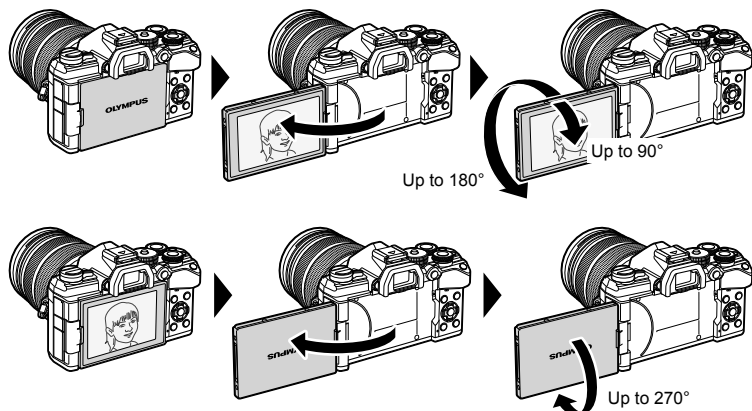

## Using the monitor

Rotate the monitor for ease of viewing. The angle of the monitor can be adjusted according to conditions at the time of shooting.

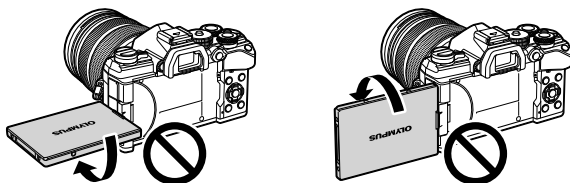

- Gently rotate the monitor within its range of motion. Attempting to rotate the monitor beyond the limits shown below could damage the connectors.



- The camera can be configured to display a mirror image of the view through the lens or automatically zoom power zoom lenses all the way out when the monitor is rotated for self portraits.  "Selfie Assist (Selfie Assist)" (P. 190)

## Turning the camera on

- 1 Set the **ON/OFF** lever to the **ON** position.
  - When the camera is turned on, the monitor will turn on.
  - To turn the camera off, return the lever to the **OFF** position.

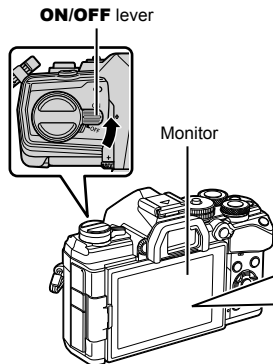

### Battery level

Battery icon and battery level are displayed.

■ (green): The camera is ready to shoot.

■ (green): The battery is not full.





■ (green): The battery is low.

■ (blinks red): Charge the battery.



## Sleep Mode

If no controls are used for a set period, the camera will automatically enter suspend operation to reduce the drain on the batteries. This is referred to as “sleep mode”.

- When the camera enters sleep mode, the monitor will turn off and operation will be suspended. Pressing the shutter or  button reactivates the camera.
- If no operations are performed for a set period after the camera enters sleep mode, the camera will turn off automatically. The camera can be reactivated by turning it on again.
- The camera may require additional time to recover from sleep mode when [On] (enabled) is selected for [Wi-Fi/Bluetooth Settings] > [Power-off Standby].  “Wireless Settings for When the Camera Is Off” (P. 202)
- The delay before the camera goes to sleep or turns off automatically can be selected in the  custom menu. At default settings, the camera will go to sleep after one minute and turn off automatically after four hours.  [Sleep] (P. 174), [Auto Power Off] (P. 174)

## Initial setup

After turning the camera on for the first time, perform the initial setup by choosing a language and setting the camera clock.

- Date and time information is recorded on the card together with the images.
- The file name is also included with the date and time information. Be sure to set the correct date and time before using the camera. Some functions cannot be used if the date and time have not been set.

- 1 Press the **OK** button when the initial setup dialog is displaying prompting you to choose a language.

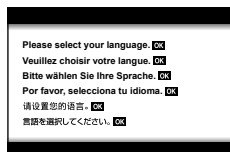

- 2 Highlight the desired language using the front or rear dial or the **△ ▽ ◀ ▶** buttons on the arrow pad.

- The language-selection dialog has two pages of options. Use the front or rear dial or the **△ ▽ ◀ ▶** buttons on the arrow pad to move the cursor between pages.

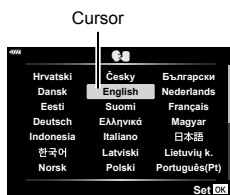

- 3 Press the **OK** button when the desired language is highlighted.





- If you press the shutter button before pressing the **OK** button, the camera will exit to shooting mode and no language will be selected. You can perform the initial setup by turning the camera off and then on again to display the initial setup dialog and repeating the process from Step 1.
- The language can be changed at any time from the **f** setup menu. **ℹ** “What to Do If You Can’t Read the Display” (P. 29)

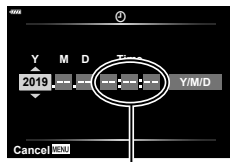

- 4** Set the date, time, and date format.
- Use the <|> buttons on the arrow pad to highlight items.
  - Use the Δ ▽ buttons on the arrow pad to change the highlighted item.
  - The clock can be adjusted at any time from the Y setup menu.  [CLOCK] (P. 159)



The time is displayed using a 24-hour clock.

- 5** Complete the initial setup.
- Press the  button to set the clock.
  - If the battery is removed from the camera and the camera is left for a while, the date and time may be reset to the factory default setting.
  - You may also need to adjust the frame rate before shooting movies.   [FR]  (P. 149)

## What to Do If You Can't Read the Display

If you see unfamiliar characters or words in other languages, you may not have selected the language you intended. Follow the steps below to choose another language.

- 1 Press the **MENU** button to view the menus.

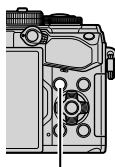

MENU button

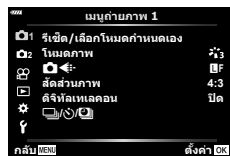

- 2 Highlight the **f** (setup) tab using  $\Delta \nabla$  on the arrow pad and press the **OK** button.

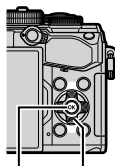

Arrow pad

OK button



- 3 Highlight **[f]** using the  $\Delta \nabla$  buttons and press the **OK** button.



- 4 Highlight the desired language using the  $\Delta \nabla \leftarrow \rightarrow$  buttons and press the **OK** button.



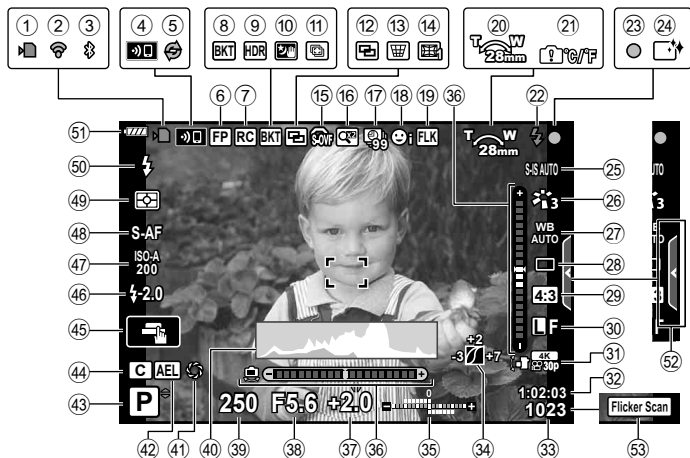

## Information displays while shooting

## Monitor display during still photography



## Monitor display during movie mode



- ① Card write indicator.....P. 19, 22
- ② Wireless LAN connection status .....P. 200–207
- ③ Active **Bluetooth**<sup>®</sup> connection .....P. 200–207
- ④ Wireless LAN connection.....P. 200–207
- ⑤ Pro Capture active .....P. 74
- ⑥ Super FP flash .....P. 215
- ⑦ RC mode.....P. 216
- ⑧ Bracketing.....P. 132
- ⑨ HDR/Backlight HDR.....P. 52, 137
- ⑩ Handheld starlight.....P. 51
- ⑪ Multi focus shot.....P. 53
- ⑫ Multiple exposure.....P. 139
- ⑬  Keystone compensation .....P. 141
- ⑭ Fisheye compensation.....P. 198
- ⑮  S-OVF\* .....P. 173
- ⑯ Digital Tele-converter.....P. 130
- ⑰ Time lapse shooting.....P. 131
- ⑱ Face priority/Eye priority .....P. 67
- ⑲ Anti-flicker shooting .....P. 185
- ⑳ Zoom operation direction/Focal length
- ㉑ Internal temperature warning.....P. 228
- ㉒ Flash  
(blinks: charging in progress, lights up:  
charging completed)
- ㉓ AF confirmation mark.....P. 35
- ㉔ Dust reduction.....P. 223
- ㉕ Image stabilizer.....P. 86
- ㉖ Picture mode.....P. 98, 129
- ㉗ White balance.....P. 83
- \* Shown in viewfinder only.
- ㉘ Sequential shooting/Self-timer/  
Anti-Shock shooting/Silent shooting/  
Pro Capture shooting/  
High resolution shooting  
.....P. 71–76, 87
- ㉙ Aspect ratio.....P. 87
- ㉚ Image quality (still images).....P. 88, 129
- ㉛ Record mode (movies) .....P. 89
- ㉜ Available recording time .....P. 242
- ㉝ Number of storable still pictures ...P. 241
- ㉞ Highlight & shadow control .....P. 106
- ㉟ Top: Flash intensity control .....P. 97  
Bottom: Exposure compensation.....P. 64
- ㊱ Level gauge .....P. 33
- ㊲ Exposure compensation value.....P. 64
- ㊳ Aperture value .....P. 37–43
- ㊴ Shutter speed .....P. 37–43
- ㊵ Histogram .....P. 33
- ㊶ Preview .....P. 108
- ㊷ AE lock.....P. 70, 175
- ㊸ Shooting mode.....P. 34–59
- ㊹ Custom mode .....P. 57, 128
- ㊺ Touch operation .....P. 36, 123
- ㊻ Flash intensity control.....P. 97
- ㊼ ISO sensitivity .....P. 70, 80
- ㊽ AF mode .....P. 80
- ㊾ Metering mode.....P. 82
- ㊿ Flash mode.....P. 93, 94
- ① Battery level.....P. 26
- ② Live guide recall.....P. 49
- ③ Flicker scan.....P. 194
- ④ Movie (exposure) mode.....P. 147
- ⑤ Movie effect .....P. 59
- ⑥ Time code .....P. 146
- ⑦ Audio recording level \* .....P. 61
- ⑧ Recording level meter.....P. 150
- ⑨ Movie sound .....P. 150
- ⑩ Silent shooting tab .....P. 61
- \* Displayed only while audio recording level is being adjusted.

## Switching between displays

The camera is equipped with an eye sensor, which turns the viewfinder on when you put your eye to the viewfinder. When you take your eye away, the sensor turns the viewfinder off and turns the monitor on.

2

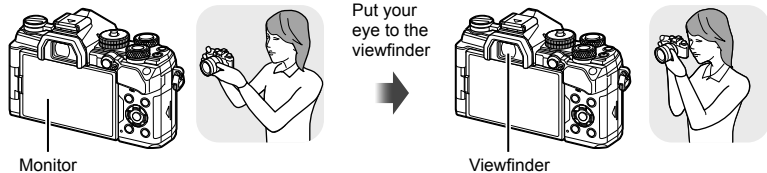

Shooting



Live view is displayed on the monitor.



The viewfinder turns on automatically when you bring it to your eye. When the viewfinder is lit up, the monitor turns off.

- If the viewfinder is not in focus, put your eye to the viewfinder and focus the display by rotating the diopter adjustment dial.
- Press the  button to switch between live view and viewfinder shooting (live view and super control panel display). If the super control panel (P. 77) is displayed in the monitor, the viewfinder will turn on when you put your eye to the viewfinder.
- You can display the EVF Auto Switch setting menu if you press and hold the  button.  [EVF Auto Switch] (P. 173)

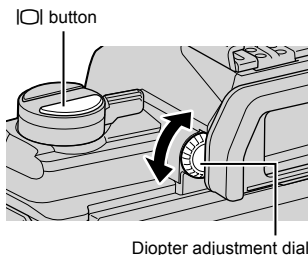



## Switching the information display

You can switch the information displayed in the monitor during shooting using the **INFO** button.

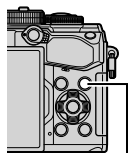

INFO button

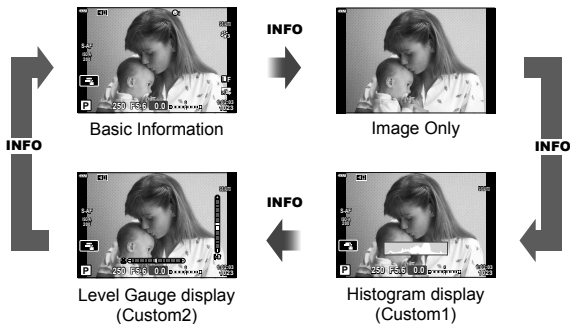

- You can change Custom1 and Custom2 settings. [Info Settings] > [LV-Info] (P. 166), [Info Settings] (P. 173)
- The information shown in movie (📹) mode can differ from that displayed in still photography mode. Video Menu > [Display Settings] (P. 146)
- The information display screens can be switched in either direction by rotating the dial while pressing the **INFO** button.

### Histogram display

A histogram showing the distribution of brightness in the image is displayed. The horizontal axis gives the brightness, the vertical axis the number of pixels of each brightness in the image. Areas above the upper limit at shooting are displayed in red, those below the lower limit in blue, and those within the spot metering range in green.

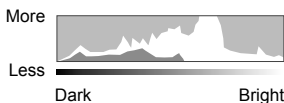

### Level gauge display

The orientation of the camera is indicated. The “tilt” direction is indicated on the vertical bar and the “horizon” direction on the horizontal bar.

- The level gauge is intended as a guide only.
- Calibrate the gauge if you find it is no longer truly plumb or level. [Level Adjust] (P. 174)

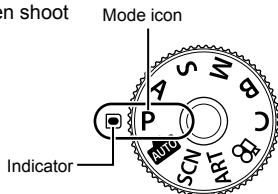

## Shooting still pictures

Use the mode dial to select the shooting mode, and then shoot the image.



### ■ Types of shooting modes

For how to use the various shooting modes, see the following.

<b>P</b>	Program AE (P. 37)
<b>A</b>	Aperture-priority AE (P. 39)
<b>S</b>	Shutter-priority AE (P. 41)
<b>M</b>	Manual exposure (P. 43)
<b>B</b>	Bulb/time (P. 45)
	Live composite (P. 47)
	AUTO (P. 49)
<b>SCN</b>	Scene (P. 50)
<b>ART</b>	Art filter (P. 55)
<b>C</b>	Custom (P. 57)
	Movie (P. 59)

**1** Press the mode dial lock to unlock it, and then turn to set the mode you wish to use.

- When the mode dial lock has been pressed down, the mode dial is locked. Each time you press the mode dial lock, it switches between locked/released.

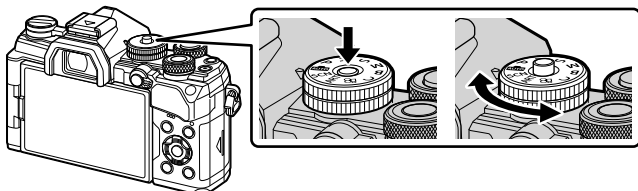

## 2 Frame the shot.

- Be careful that your fingers or the camera strap do not obstruct the lens or AF illuminator.

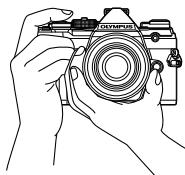

Landscape position

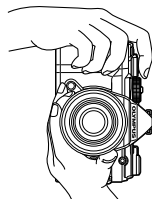

Portrait position

## 3 Adjust the focus.

- Lightly press the shutter button down to the first position (press the shutter button halfway).  
The AF confirmation mark (●) will be displayed, and a green frame (AF target) will be displayed in the focus location.

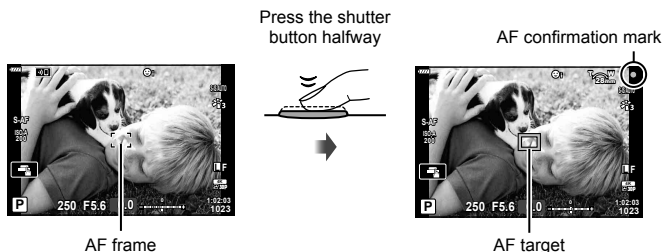

- If the camera is unable to focus, the AF confirmation mark will flash (P. 224).
- The AF frame varies with the option chosen for AF-target mode. The area covered by the AF target can be chosen in the AF-target selection display (P. 65). The AF frame is not displayed when (all targets) is chosen for AF-target mode.

## 4 Release the shutter.

- Press the shutter button all the way (fully).
- The camera will release the shutter and take a picture.
- The shot image will be displayed on the monitor.
- You can focus and take pictures using touch controls. "Shooting with touch screen operations" (P. 36)



### Pressing the shutter button halfway and all the way down

The shutter button has two positions. The act of lightly pressing the shutter button to the first position and holding it there is called "pressing the shutter button halfway", that of pressing it all the way down to the second position "pressing the shutter button all (or the rest of) the way down".





## Shooting with touch screen operations

Tap  to cycle through touch screen settings.

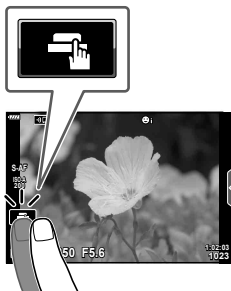
-  Tap a subject to focus and automatically release the shutter. This function is not available in movie mode.
-  Touch screen operations are disabled.
-  Tap to display an AF target and focus on the subject in the selected area. You can use the touch screen to choose the position and size of the focus frame. Photographs can be taken by pressing the shutter button.



### ■ Previewing the subject ()

- 1 Tap the subject in the display.
  - An AF target will be displayed.
  - Use the slider to choose the size of the frame.
  - Tap  to turn off the display of the AF target.
  
- 2 Use the slider to adjust the size of the AF target, and then tap  to zoom in at the frame position.
  - Use your finger to scroll the display when the picture is zoomed in.
  - Tap  to cancel the zoom display.

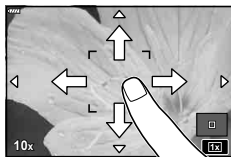

- The situations in which touch screen operations are not available include the following.
  - In the one-touch capture white-balance display and when buttons or dials are in use
  - Do not touch the display with your fingernails or other sharp objects.
  - Gloves or monitor covers may interfere with touch screen operation.
  - You can disable the touch screen operation.  [Touchscreen Settings] (P. 174)

## Letting the camera choose aperture and shutter speed

(P: Program AE)

The camera chooses the optimal aperture and shutter speed according to subject brightness.

- 1 Rotate the mode dial to **P**.

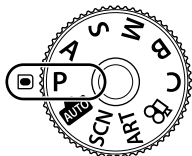

- 2 Focus and check the display.
  - The shutter speed and aperture chosen by the camera are displayed.
- 3 Take pictures.

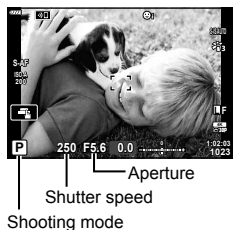

### Subject Too Dark or Too Bright

If the camera is unable to achieve optimal exposure, the shutter-speed and aperture displays will flash as shown.

Display	Problem/solution
Large aperture (low f/-number)/ slow shutter speed 	The subject is too dark. <ul style="list-style-type: none"> <li>• Use a flash.</li> </ul>
Small aperture (high f/-number)/ fast shutter speed 	Subject is too bright. <ul style="list-style-type: none"> <li>• The limits of the camera metering system have been exceeded. Use a third-party ND (Neutral Density) filter to reduce the amount of light entering the camera.</li> <li>• Take pictures in silent mode.  "Shooting without shutter sound (Silent [♥])" (P. 74)</li> </ul>



- When using a fixed [ISO] setting, change the setting. "Changing ISO sensitivity (ISO)" (P. 70, 80)
- The aperture value shown when the displays flash varies with the lens and focal length.

## ■ Adjusting Settings in Mode P





Use the front and rear dials to adjust the following settings.

Front dial: Exposure compensation (P. 64)

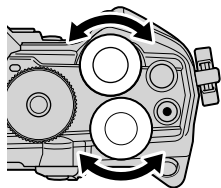
Rear dial: Program shift

- Exposure compensation can also be adjusted using the  button. Press the  button and rotate the front or rear dial.



- You can choose the functions performed by the front and rear dials.  [  Dial Function ] (P. 164)
- You can use the **Fn** lever to reverse the roles of the front and rear dials. The lever can also be assigned other roles.  [  Fn Lever Function ] (P. 181)

## ■ Program Shift

Without changing exposure, you can choose from different combinations of aperture and shutter speed selected automatically by the camera. This is known as program shift.

- Rotate the rear dial until the camera displays the desired combination of aperture and shutter speed.
- The shooting mode indicator in the display changes from **P** to **Ps** while program shift is in effect. To end program shift, rotate the rear dial in the opposite direction until **Ps** is no longer displayed.



Program shift



- You can choose whether the display reflects the effects of exposure compensation or maintains a constant brightness for ease of viewing. At default settings, the effects of exposure settings are visible in the display.  [Live View Boost] (P. 167)

## Choosing aperture

## (A: Aperture-Priority AE)

In this mode, you choose the aperture (*f*-number) and the camera automatically sets the shutter speed for optimal exposure according to subject brightness. Lower aperture values (larger apertures) reduce the depth of the area that appears to be in focus (depth of field), blurring the background. Higher aperture values (smaller apertures) increase the depth of the area that appears to be in focus in front of and behind the subject.



### 1 Rotate the mode dial to **A**.

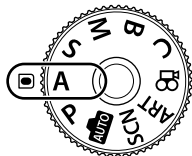

### 2 Choose an aperture.

- At default settings, aperture is selected by rotating the rear dial.
- The shutter speed selected automatically by the camera will appear in the display.



### 3 Take pictures.



Aperture value

**Subject Too Dark or Too Bright**

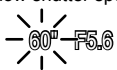
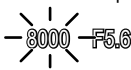
If the camera is unable to achieve optimal exposure, the shutter-speed display will flash as shown.

Display	Problem/solution
Slow shutter speed 	Underexposure. • Choose a lower aperture value.
Fast shutter speed 	Overexposure. • Choose a higher aperture value. • If the subject is still overexposed at the higher value, the limits of the camera metering system have been exceeded. Use a third-party ND (Neutral Density) filter to reduce the amount of light entering the camera. • Take pictures in silent mode.  "Shooting without shutter sound (Silent [♥])" (P. 74)



- When using a fixed [ISO] setting, change the setting.  "Changing ISO sensitivity (ISO)" (P. 70, 80)

**■ Adjusting Settings in Mode A**





Use the front and rear dials to adjust the following settings.

Front dial: Exposure compensation (P. 64)

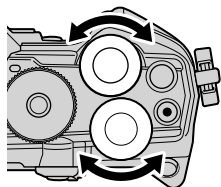
Rear dial: Aperture

- Exposure compensation can also be adjusted using the  button. Press the  button and rotate the front or rear dial.



- You can choose the functions performed by the front and rear dials.  [Dial Function] (P. 164)
- You can use the **Fn** lever to reverse the roles of the front and rear dials. The lever can also be assigned other roles.  [Fn Lever Function] (P. 181)
- You can choose whether the display reflects the effects of exposure settings or maintains a constant brightness for ease of viewing. At default settings, the effects of exposure settings are visible in the display.  [Live View Boost] (P. 167)
- You can stop aperture down to the selected value and preview depth of field.  [Button Function] (P. 108)



## Choosing shutter speed (S: Shutter-Priority AE)

In this mode, you choose the shutter speed and the camera automatically sets aperture for optimal exposure according to subject brightness. Faster shutter speeds appear to “freeze” fast-moving subjects. Slower shutter speeds add blur to moving objects, lending them a sense of motion for a dynamic effect.

Slower shutter speeds...

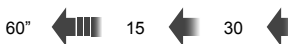

...produce dynamic shots with a sense of motion.

Faster shutter speeds...

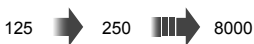

...“freeze” the motion of fast-moving subjects.

### 1 Rotate the mode dial to S.

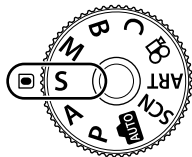

### 2 Choose a shutter speed.

- At default settings, shutter speed is selected by rotating the rear dial.
- Shutter speed can be set to values between 1/8000 and 60 s.
- Shutter speeds as fast as 1/32000 s are available in [♥] (silent) mode. [♥] “Shooting without shutter sound (Silent [♥])” (P. 74)
- The aperture selected automatically by the camera will appear in the display.





Shutter speed

### 3 Take pictures.

**Subject Too Dark or Too Bright**

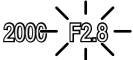
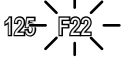
If the camera is unable to achieve optimal exposure, the aperture display will flash as shown.

Display	Problem/solution
Low aperture value 	Underexposure. • Choose a slower shutter speed.
High aperture value 	Overexposure. • Choose a faster shutter speed. Shutter speeds as fast as 1/32000 s are available in silent mode. • If the subject is still overexposed at the higher speed, the limits of the camera metering system have been exceeded. Use a third-party ND (Neutral Density) filter to reduce the amount of light entering the camera.



- When using a fixed [ISO] setting, change the setting.  "Changing ISO sensitivity (ISO)" (P. 70, 80)
- The aperture value shown when the display flashes varies with the lens and focal length.

**■ Adjusting Settings in Mode S**





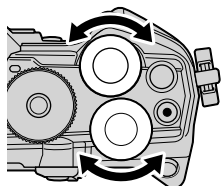

Use the front and rear dials to adjust the following settings.

Front dial: Exposure compensation (P. 64)

Rear dial: Shutter speed

- Exposure compensation can also be adjusted using the  button. Press the  button and rotate the front or rear dial.



- You can choose the functions performed by the front and rear dials.  [  Dial Function ] (P. 164)
- You can use the **Fn** lever to reverse the roles of the front and rear dials. The lever can also be assigned other roles.  [  Fn Lever Function ] (P. 181)
- You can choose whether the display reflects the effects of exposure settings or maintains a constant brightness for ease of viewing. At default settings, the effects of exposure settings are visible in the display.  [Live View Boost] (P. 167)
- Depending on the shutter speed selected, you may notice banding in the display caused by flicker from fluorescent or LED light sources. The camera can be configured to reduce the effects of flicker during live view or when pictures are taken.  [Flicker Reduction] (P. 184), [  Flicker Scan ] (P. 194)

## Choosing aperture and shutter speed (M: Manual Exposure)

In this mode, you choose the aperture and shutter speed. You can adjust settings according to your goals, for example by combining fast shutter speeds with small apertures (high *f*-numbers) for increased depth of field.

### 1 Rotate the mode dial to M.

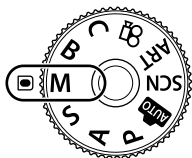

### 2 Adjust aperture and shutter speed.

- At default settings, aperture is selected with the front dial and shutter speed with the rear dial.
- Choose from shutter speeds of 1/8000–60 s.
- Shutter speeds as fast as 1/32000 s are available in silent mode. "Shooting without shutter sound (Silent [♥])" (P. 74)
- The display shows the difference between the exposure produced by the selected aperture and shutter speed and the optimal exposure metered by the camera. The display will flash if the difference exceeds  $\pm 3$  EV.
- When [AUTO] is selected for [ISO], ISO sensitivity will automatically be adjusted for optimal exposure at the selected exposure settings. [ISO] defaults to [AUTO]. "Changing ISO sensitivity (ISO)" (P. 70, 80)



### 3 Take pictures.

#### Subject Too Dark or Too Bright

If the camera is unable to achieve optimal exposure with [AUTO] selected for [ISO], the ISO sensitivity display will flash as shown.

Display	Problem/solution
	Overexposure. • Choose a higher aperture value or faster shutter speed.
	Underexposure. • Choose a lower aperture value or slower shutter speed. • If the warning does not clear from the display, choose a higher value for ISO sensitivity.  "Changing ISO sensitivity (ISO)" (P. 70, 80), [ISO-Auto Set] (P. 169)

## ■ Adjusting Settings in Mode M

Use the front and rear dials to adjust the following settings.

Front dial: Aperture

Rear dial: Shutter speed

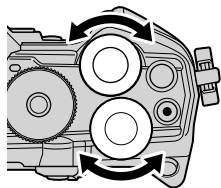

- You can choose the functions performed by the front and rear dials. [Camera Dial Function] (P. 164)
- You can use the **Fn** lever to reverse the roles of the front and rear dials. The lever can also be assigned other roles. [Fn Lever Function] (P. 181)
- Depending on the shutter speed selected, you may notice banding in the display caused by flicker from fluorescent or LED light sources. The camera can be configured to reduce the effects of flicker during live view or when pictures are taken. [Flicker Reduction] (P. 184), [Flicker Scan] (P. 194)
- You can choose whether the display reflects the effects of exposure settings or maintains a constant brightness for ease of viewing. At default settings, the display maintains a constant brightness for ease of viewing. [Live View Boost] (P. 167)

## ■ Using Exposure Compensation in Mode M

In mode **M**, exposure compensation is available when [AUTO] is selected for [ISO]. Because exposure compensation is performed by adjusting ISO sensitivity, aperture and shutter speed are not affected. “Changing ISO sensitivity (ISO)” (P. 70, 80), [ISO-Auto Set] (P. 169)

- Exposure compensation can be adjusted using the button. Hold the button and rotate the front or rear dial.
- Exposure compensation is added to the exposure difference shown in the display.



Exposure compensation

Exposure compensation plus exposure difference

## Long Exposures

(**B**: Bulb/Time)

Select this mode to leave the shutter open for a long exposure. You can preview the photo in live view and end the exposure when the desired results have been achieved. Use when long exposures are required, for example when photographing night scenes or fireworks.

### “Bulb” and “Live Bulb” Photography

The shutter remains open while the shutter button is pressed. Releasing the button ends the exposure.

- The amount of light entering the camera increases the longer the shutter is open.
- When live bulb photography is selected, you can choose how often the camera updates the live view display during the exposure.

### “Time” and “Live Time” Photography

The exposure begins when the shutter button is pressed all the way down. To end the exposure, press the shutter button all the way down a second time.

- The amount of light entering the camera increases the longer the shutter is open.
- When live time photography is selected, you can choose how often the camera updates the live view display during the exposure.

- 1 Rotate the mode dial to **B**.

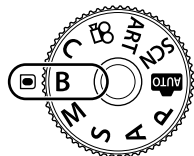

- 2 Select bulb or time photography.

- At default settings, the selection is made with the rear dial.

- 3 Press the **MENU** button.

- You will be prompted to choose the interval at which the preview is updated.



Bulb or time photography

- 4 Highlight an interval using  $\Delta$   $\nabla$  on the arrow pad.

- 5 Press the **OK** button to select the highlighted option.

- The menus will be displayed.

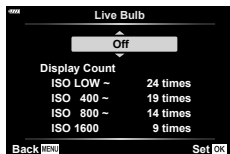

- 6 Press the **MENU** button to exit the menus.

- If an option other than [Off] is selected, [LIVE BULB] or [LIVE TIME] will appear in the display.

## 7 Adjust aperture.

- At default settings, aperture can be adjusted using the front dial.



Aperture

## 8 Take pictures.

- In bulb and live bulb modes, keep the shutter button pressed. The exposure ends when the button is released.
- In time and live time modes, press the shutter button all the way down once to start the exposure and again to end it.
- The exposure ends automatically when the time selected for [Bulb/Time Timer] is reached. The default is [8 min]. The time can be changed. [Bulb/Time Timer] (P. 170)
- [Noise Reduct.] is applied after shooting. The display shows the time remaining until the process is complete. You can choose the conditions under which noise reduction is performed (P. 169).
- During live time photography, you can refresh the preview by pressing the shutter button halfway.
- Some limitations apply to the choice of ISO sensitivity settings available.
- Bulb photography is used in place of live bulb photography when multiple exposure, keystone compensation, or fisheye correction is in effect.
- Time photography is used in place of live time photography when multiple exposure, keystone compensation, or fisheye correction is in effect.
- During shooting, there are limits on the settings for the following functions. Sequential shooting, self-timer shooting, time lapse shooting, AE bracket shooting, image stabilizer, flash bracketing, multiple exposure\*, etc.  
\* When an option other than [Off] is selected for [Live Bulb] or [Live Time] (P. 170)
- [Image Stabilizer] (P. 86) turns off automatically.
- Depending on camera settings, the temperature, and the situation, you may notice noise or bright spots in the monitor. These may sometimes appear in pictures even when [Noise Reduct.] (P. 169) is enabled.



- Display brightness can be adjusted during bulb/time photography. At default settings, the display is darker than normal. [Bulb/Time Monitor] (P. 170)
- During bulb/time photography, the brightness of the subject in the display is enhanced for ease of viewing when lighting is poor. [Live View Boost] (P. 167)
- In mode **B** (bulb), you can adjust focus manually while the exposure is in progress. This allows you to defocus during the exposure or focus at the end of the exposure. [Bulb/Time Focusing] (P. 180)

## Noise

While shooting at slow shutter speeds, noise may appear on screen. These phenomena occur when the temperature rises in the image pickup device or image pickup device internal drive circuit, causing current to be generated in those sections of the image pickup device that are not normally exposed to light. This can also occur when shooting with a high ISO setting in a high-temperature environment. To reduce this noise, the camera activates the noise reduction function.  [Noise Reduct.] (P. 169)

## Lighten Blending (B: Live Composite Photography)

Leave the shutter open for a long exposure. You can view the light trails left by fireworks or stars and photograph them without changing the exposure of the background. The camera combines multiple shots and records them as a single photograph.

- 1 Rotate the mode dial to **B**.

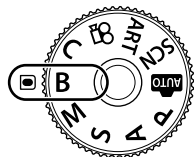

- 2 Select [LIVE COMP].
  - At default settings, the selection is made with the rear dial.
- 3 Press the **MENU** button.
  - The [Composite Settings] menu will be displayed.



Live composite photography

- 4 Highlight an exposure time using  $\Delta$   $\nabla$  on the arrow pad.
  - Choose an exposure time of from 1/2 to 60 s.
- 5 Press the **OK** button to select the highlighted option.
  - The menus will be displayed.

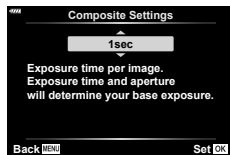



- 6 Press the **MENU** button repeatedly to exit the menus.
- 7 Adjust aperture.
  - At default settings, aperture can be adjusted using the front dial.
- 8 Press the shutter button all the way down to ready the camera.
  - The camera is ready to shoot when [Ready for composite shooting] is displayed.



- 9** Press the shutter button to start shooting.
- Live composite photography will start. The display will be updated after each exposure.
- 10** Press the shutter button again to end shooting.
- Live composite photography can continue for up to three hours. The maximum recording time available varies with battery level and shooting conditions.
  - Some limitations apply to the choice of ISO sensitivity settings available.
  - Limitations apply to some features during shooting, including:
    - sequential shooting, the self-timer, interval timer photography, AE bracketing, flash bracketing, focus bracketing, High Res Shot, HDR photography, multiple exposure, keystone compensation, and fisheye correction.
  - [Image Stabilizer] (P. 86) turns off automatically.



- Display brightness can be adjusted during live composite photography. At default settings, the display is darker than normal.  [Bulb/Time Monitor] (P. 170)
- The exposure time for each exposure made during live composite photography can be chosen in advance using the menus.  [Composite Settings] (P. 193)



## Letting the camera choose the settings (AUTO mode)

The camera adjusts settings to suit the scene; all you have to do is press the shutter button.

Use live guides to easily adjust such parameters as color, brightness, and background blurring.

### 1 Set the mode dial to **AUTO**.

- In auto mode, the camera automatically selects the scene mode option appropriate to your subject when you press the shutter button halfway. Once the selection has been made, the **AUTO** icon in the bottom left corner of the display will be replaced by the icon for the chosen scene.

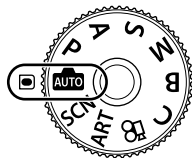

### 2 To adjust shooting settings, display the live guide by pressing the **OK** button.

- Use  $\Delta$ / $\nabla$  to highlight an item in the live guide and press **OK** to display a slider.



Guide item

### 3 Use $\Delta$ / $\nabla$ to position the slider and choose a level.

- Press the **OK** button to save changes.
- To exit, press the **MENU** button.
- When [Shooting Tips] is selected, use  $\Delta$ / $\nabla$  to highlight the item and press the **OK** button to display the detail.
- The effect of the selected level is visible in the display. If [Blur Background] or [Express Motions] is selected, the display will return to normal, but the selected effect will be visible in the final photograph.



Slider

### 4 To set multiple live guides, repeat Steps 2 and 3.

- A check is displayed on the guide item for live guides that are already set.
- [Blur Background] and [Express Motions] cannot be set at the same time.



### 5 Take pictures.

- To clear the live guides from the display, press the **MENU** button.
- If [RAW] is currently selected for image quality, image quality will automatically be set to RAW+JPEG.
- Live guide settings are not applied to the RAW copy.
- Pictures may appear grainy at some live guide setting levels.

- Changes to live guide setting levels may not be visible in the monitor.
- Frame rates drop the closer the [Express Motions] slider is to [Blurred Motion].
- The flash cannot be used when a live guide is set.
- Choosing live guide settings that exceed the limits of the camera exposure meters may result in pictures that are overexposed or underexposed.



- Touch controls can also be used.

## Shooting in scene mode (SCN mode)

The camera automatically optimizes settings for the subject or scene.

- 1 Rotate the mode dial to **SCN**.

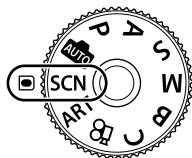

- 2 Use  $\Delta$   $\nabla$   $\triangleleft$   $\triangleright$  to highlight a scene and press the  $\text{OK}$  button.





















- 3 Use  $\triangleleft$   $\triangleright$  to highlight a scene mode and press the  $\text{OK}$  button.

















- 4 Take pictures.
  - To choose a different scene, press the  $\text{OK}$  button. Next, press the **MENU** button to return to the scene-selection display.

## Types of scene modes

Subject type	Scene mode	Description
People	 Portrait	Suitable for portrait shooting. Brings out skin texture.
	 e-Portrait	Smooths out skin tones and texture. The camera records two pictures: one with the effect applied and one without.
	 Portrait + Landscape	Suitable for portraits featuring a landscape in the background. Blues, greens, and skin tones are captured beautifully.
	 Portrait + Nightscape	Suitable for portrait shooting against a background of night view. Attach an external flash unit designed for use with the camera (P. 93). We recommend that you use a tripod and either OI.Share or a remote cable (P. 204, 219).
	 Children	Suitable for photographs of children and other active subjects.
Nightscapes	 Nightscape	Suitable for tripod shooting of night scenes. We recommend that you use a tripod and either OI.Share or a remote cable (P. 204, 219).
	 Portrait + Nightscape	Suitable for portrait shooting against a background of night view. Attach an external flash unit designed for use with the camera (P. 93). We recommend that you use a tripod and either OI.Share or a remote cable (P. 204, 219).
	 Handheld Starlight	Suitable for shooting night scenes without a tripod. Reduces blur when shooting low light/illuminated scenes. The camera makes eight exposures and combines them into a single photograph.
	 Fireworks	Suitable for shooting fireworks at night. We recommend that you use a tripod and either OI.Share or a remote cable (P. 204, 219).





Subject type	Scene mode	Description
Nightscapes	 Light Trails	<p>The camera automatically shoots multiple images, takes newly bright areas only, and composites them into a single image.</p> <p>With normal long exposure, an image of light trace such as star trails with bright buildings tends to get too bright. You can capture them without over exposure while checking the progress.</p> <p>Press the shutter button to start shooting, then view the changing result in the monitor and press the shutter button again to end shooting once the desired result is achieved (maximum 3 hours).</p> <p>We recommend that you use a tripod and either OI.Share or a remote cable (P. 204, 219).</p> <ul style="list-style-type: none"> <li>Advanced settings can be accessed via live composite photography (dark and light field composite) in <b>B</b> mode (P. 47).</li> </ul>
Motion	 Sport	<p>Suitable for fast action shooting.</p> <p>The camera will take photos while the shutter button is pressed.</p>
	 Children	Suitable for photographs of children and other active subjects.
	 Panning	<p>Choose to blur the background behind moving objects.</p> <p>The camera chooses the optimal shutter speed for panning shots based on camera motion.</p>
Scenery	 Landscape	Suitable for landscape shooting.
	 Sunset	Suitable for shooting the sunset.
	 Beach & Snow	Suitable for shooting at snow-capped mountains, seascapes in the sun, and other whitish scenes.
	 Panorama	<p>Take photos that can afterwards be joined on a computer to create a panorama.</p> <ul style="list-style-type: none"> <li>For information on taking photos using this feature, see "Shooting a Panorama" (P. 54).</li> </ul>
	 Backlight HDR	Suitable for high-contrast scenes. Each time the shutter button is pressed, the camera takes four shots and subsequently merges them into one, correctly exposed image.

Subject type	Scene mode	Description
Indoors	 Candlelight	Suitable for shots of candlelit scenes. Warm colors are preserved.
	 Silent [ 	Disable camera sounds and lights in situations in which they may be unwelcome (P. 74).
	 Portrait	Suitable for portrait shooting. Brings out skin texture.
	 e-Portrait	Smooths out skin tones and texture. The camera records two pictures: one with the effect applied and one without.
	 Children	Suitable for photographs of children and other active subjects.
	 Backlight HDR	Suitable for high-contrast scenes. Each time the shutter button is pressed, the camera takes four shots and subsequently merges them into one, correctly exposed image.
Close-ups	 Macro	Suitable for close-ups.
	 Nature Macro	Suitable for vivid close-ups of flowers or insects.
	 Documents	Suitable for photos of timetables or other documents. The camera heightens the contrast between the text and background.
	 Multi Focus Shot	The camera takes eight photos, varying the focus distance with each shot.

- To maximize the benefits of the scene modes, some of the shooting function settings are disabled.
- Some time may be needed to record pictures taken using [e-Portrait]. In addition, when the image quality mode is [RAW], the image is recorded in RAW+JPEG.
- Movies cannot be recorded using [e-Portrait], [Handheld Starlight], [Panorama], or [Backlight HDR].
- Movie recording is not available in [Light Trails] mode when <sup>FHD HS</sup>60P (high-speed movie recording) is selected for [].
- [Handheld Starlight] pictures taken with [RAW] selected for image quality will be recorded in RAW+JPEG format, with the first frame recorded as a RAW image and the final composite as a JPEG image.
- [Backlight HDR] records HDR-processed images in JPEG format. When the image quality mode is set to [RAW], the image is recorded in RAW+JPEG.
- In [Panning],  is displayed during panning detection, and  is displayed when nothing is detected.
- When using a lens with an image stabilizer switch in [Panning], turn the image stabilizer switch off.  
Sufficient panning effects may not be obtained in bright conditions. Use a commercially available ND filter to obtain effects more easily.
- Shooting will end if zoom is adjusted while photographs are being taken in [Multi Focus Shot] mode.
- No pictures can be taken in [Multi Focus Shot] mode when a Four-Thirds lens is attached.

## ■ Shooting a Panorama



Pictures taken using this option can be joined together to form a panorama. You will need to install the latest version of Olympus Workspace on your computer to join pictures together to form a panorama.  “Connecting the camera to a computer” (P. 208)

- 1 Highlight [Panorama] in the **SCN** mode menu (P. 51) and press the  button.
- 2 Use     to choose a pan direction.
- 3 Take a picture, using the guides to frame the shot.
  - Focus, exposure, and other settings are fixed at the values for the first shot.



- 4 Take the remaining images, framing each shot so that the guides overlap with the previous picture.



- A panorama may include up to 10 images. A warning indicator () is displayed after the tenth shot.
  - During panorama shooting, the image previously taken for position alignment will not be displayed. With the frames or other markers for display in the images as a guide, set the composition such that the edges of the overlapping images overlap within the frames.
- 5 After taking the last shot, press  to end the series.

## Using art filters

(ART mode)

- 1 Rotate the mode dial to **ART**.
- 2 Use  $\triangleleft$   $\triangleright$  to highlight a filter.
- 3 Press  $\nabla$ , highlight an effect using  $\triangleleft$   $\triangleright$ , and press the  $\text{OK}$  button.
- 4 Take pictures.
  - Press the  $\text{OK}$  button to choose a different art filter. If effects are displayed, press  $\triangle$ .
  - The effects available vary with the selected filter (Soft Focus Effect, Pin Hole Effect, Frame Effect, White Edge Effect, Star Light Effect, Color Filter, Monochrome Color, Blur Effect, or Shade Effect).

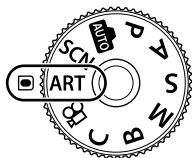

### ■ Types of art filters

<b>Pop Art I/II *</b>	Creates an image that emphasizes the beauty of color.
<b>Soft Focus</b>	Creates an image that expresses a soft tone atmosphere.
<b>Pale&amp;Light Color I/II *</b>	Creates an image that expresses warm light by scattering overall light and slightly overexposing the image.
<b>Light Tone</b>	Creates a high-quality image by softening both shadows and highlights.
<b>Grainy Film I/II *</b>	Creates an image that expresses the roughness of black and white images.
<b>Pin Hole I/II/III *</b>	Creates an image that looks as if it was taken using an old or toy camera by dimming the image perimeter.
<b>Diorama I/II *</b>	Creates a miniature-like image by emphasizing saturation and contrast, and blurring unfocused areas.
<b>Cross Process I/II *</b>	Creates an image that expresses a surreal atmosphere. Cross Process II creates an image that emphasizes magenta.
<b>Gentle Sepia</b>	Creates a high-quality image by drawing out shadows and softening the overall image.
<b>Dramatic Tone I/II *</b>	Creates an image that emphasizes the difference between brightness and darkness by partially increasing contrast.
<b>Key Line I/II *</b>	Creates an image that emphasizes edges and adds an illustrative style.

2

Shooting

<b>Watercolor I/II *</b>	Creates a soft, bright image by removing dark areas, blending pale colors on a white canvas, and further softening contours.
<b>Vintage I/II/III *</b>	Expresses an everyday shot in a nostalgic, vintage tone using printed film discoloration and fading.
<b>Partial Color I/II/III *</b>	Impressively expresses a subject by extracting colors you want to emphasize and keeping everything else monotone.
<b>Bleach Bypass I/II</b>	The “bleach bypass” effect, which you may recognize from motion pictures and the like, can be used to great effect in shots of streetscapes or metal objects.
<b>Instant Film</b>	A contemporary take on the shadow and skin tones typical of film.
<b>ART BKT (ART bracketing)</b>	Records images using all art filter options with a single shot. Press the <b>INFO</b> button on the selection screen to select a filter to record with.

\* II and III are altered versions of the original (I).

- To maximize the benefits of the art filters, some of the shooting function settings are disabled.
- If [RAW] is currently selected for image quality (P. 88, 129), image quality will automatically be set to RAW+JPEG. The art filter will be applied to the JPEG copy only.
- Depending on the subject, tone transitions may be ragged, the effect may be less noticeable, or the image may become more “grainy”.
- Some effects may not be visible during movie recording.
- Playback may differ according to the filters, effects, or movie quality settings applied.

### ■ Using [Partial Color]

Record only selected hues in color.

- 1 Rotate the mode dial to **ART**.
- 2 Select [Partial Color I/II/III] in the art filter menu.
- 3 Highlight an effect and press the **OK** button.
  - A color ring appears in the display.
- 4 Rotate the front or rear dial to select a color.
  - The effect is visible in the display.
- 5 Take pictures.
  - To choose a different color after shooting, rotate the front or rear dial to display the color ring.







Save settings as a Custom Mode (C mode) for instant recall.

- Custom settings can be saved by selecting [Custom Mode C] for [Reset / Custom Modes] > [Assign to Custom Mode] (P. 128) in  Shooting Menu 1.
- Custom settings can be recalled by rotating the mode dial to **C**.
- At default settings, custom modes are equivalent to mode **P**.

## Recording Movies

### Recording movies in photo shooting modes





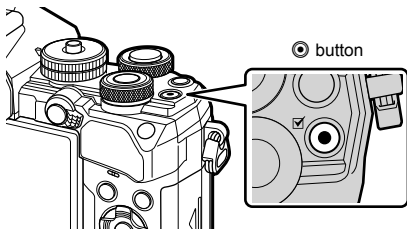

The  button can be used for movie recording even when the mode dial is not in the  position.

**1** Press the  button to begin recording.

- Movie you are recording will be displayed on the monitor.
- If you put your eye to the viewfinder, movie you are recording will be displayed in the viewfinder.
- You can change the focus location by tapping the screen while recording.



**2** Press the  button again to end recording.

- The sound of touch operations and button operations may be recorded.
- CMOS image sensors of the type used in the camera generate a so-called “rolling shutter” effect that can cause distortion in pictures of moving objects. This distortion is a phenomenon that occurs in pictures of fast-moving subjects or if the camera is moved during shooting. It is particularly noticeable in pictures taken at long focal lengths.
- If the size of the movie file being recorded exceeds 4 GB, the file will be split automatically. (Depending on shooting conditions, movies under 4 GB in size may be split into multiple files.)
- When recording movies, use an SD card that supports an SD speed class of 10 or higher.
- A UHS-II or UHS-I card with a UHS speed class of 3 or better is required when:
  - a movie resolution of [4K] or [C4K] is selected in the   menu or a bit rate of [A-I] (All-Intra) is selected in the   menu
- If the camera is used for extended periods, the temperature of the image pickup device will rise and noise and colored fog may appear in images. Turn off the camera for a short time. Noise and colored fog may also appear in images recorded at high ISO sensitivity settings. If the temperature rises further, the camera will turn off automatically.
- When using a Four Thirds system lens, the AF will not operate while recording movies.
- The  button cannot be used to record movies in the following instances:
  - During multiple exposure (still photography also ends.), while shutter button is pressed halfway, during bulb/time photography, during sequential shooting, during time lapse shooting, in **B** mode, during fisheye correction
- When <sup>PHD</sup> <sub>60p</sub> (high-speed movie recording) is selected for  , movies shot with [i-Enhance], [e-Portrait], or an art filter selected for picture mode will be recorded in [Natural] mode.



- Some settings, such as AF mode, can be set separately for movies and photographs.  
 "Using the Video Menu" (P. 144)



## Recording movies in movie mode

When the mode dial is rotated to , movies can be recorded by pressing the shutter button.

The effects available in **P**, **S**, **A**, and **M** modes can be applied to movies (P. 147). You can also use movie effects such as after-images or zooming in on an area of the image during recording.





- A beep does not sound when the camera focuses in movie mode.

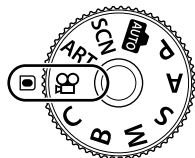

### ■ Adding effects to a movie (Movie Effect)

You must first select [Movie Effect] on the screen that can be displayed by selecting the Video Menu >  Display Settings >  Info Settings > [Custom1] and pressing  (P. 146).

- Rotate the mode dial to .
- Tap the on-screen icon of the effect you wish to use.
  - Tap the display to add effects during shooting.
  - Effects can be added by tapping the display before starting recording.



	<b>Art Fade</b>	Films with the selected picture mode effect. The fade effect is applied to the transition between scenes.
	<b>Old Film</b>	Randomly applies damage and dust-like noise similar to old movies.
	<b>Multi Echo</b>	Applies an after-image effect. After-images will appear behind moving objects.
	<b>One Shot Echo</b>	Applies an after-image for a short time after you tap the icon. The after-image will disappear automatically after a while.
	<b>Movie Tele-converter</b>	Zooms in on an area of the image without using the lens zoom. The selected position of the image can be zoomed in even while the camera is kept fixed.

- Press the  button to start recording.
- Press the  button again to end recording.
  - The **INFO** button also controls the display of shooting information during movie recording. Note, however, that pressing the **INFO** button during recording cancels all movie effects except art fade and movie tele-converter.

**Art Fade**

Tap the icon. The effect will be applied gradually when you tap the icon of a picture mode.

- Movies shot in partial color use the color selected in **ART** mode.

**Old Film**

Tap the icon for the effect to be applied. Tap again to cancel the effect.

**Multi Echo**

Tap the icon for the effect to be applied. Tap again to cancel the effect.

**One Shot Echo**

Each tap of the icon adds the effect.

**Movie Tele-converter**

Tap the icon to zoom in on a selected area of the frame.

**1** Tap the icon to display the zoom frame.

- You can change the position of the zoom frame by tapping the screen or using  $\Delta \nabla \triangleleft \triangleright$ .
- Press and hold the  $\text{OK}$  button to return the zoom frame to a central position.

**2** Tap  to zoom in on the area in the zoom frame.

- Tap  to return to the zoom frame display.

**3** Tap  or press the  $\text{OK}$  button to cancel the zoom frame and exit Movie Tele-converter mode.

- The 2 effects cannot be applied simultaneously.
- Some effects may not be available depending on the picture mode.
- The sound of touch operations and button operations may be recorded.
- The drive mode displayed in the movie mode is the setting for still image shooting. Still image shooting is not available in the movie mode.
- Using art filter or movie effects may cause the frame rate to drop.
- Art filters cannot be used for high-speed recording or slow- or fast-motion movies.
- With the exception of the movie tele-converter, movie effects cannot be used in movie-only picture modes, for high-speed recording, or for slow- or fast-motion movies.
- Movie Tele-converter is not available when [C4K] or [4K] is set for the image size.

## Silencing Camera Sounds While Shooting Movies

You can prevent the camera from recording operating sounds that occur due to camera operations while shooting.

Tap the silent shooting tab to display the function items. After tapping an item, tap the displayed arrows to select the settings.





- Electronic zoom\*, recording volume, aperture, shutter speed, exposure compensation, ISO sensitivity
  - \* Only available with power zoom lenses
- The options available vary with the shooting mode.

Silent shooting tab



## Shooting Settings





The camera offers many photography-related functions. Depending on how often you use them, you can access settings via buttons, icons in the display, or menus that can be used for detailed adjustments.

Method	Description	
Direct buttons	Adjust settings directly using buttons, including those listed below. Commonly-used functions are assigned to buttons for quick access during viewfinder photography. <ul style="list-style-type: none"><li>• The , , and  buttons</li></ul>	63
LV super control panel/ super control panel	Choose from a list of settings showing current camera status. You can also view current camera settings.	77
Live controls	Adjust settings while viewing your subject in the display.	187
Menus	Adjust settings from menus displayed in the monitor.	125

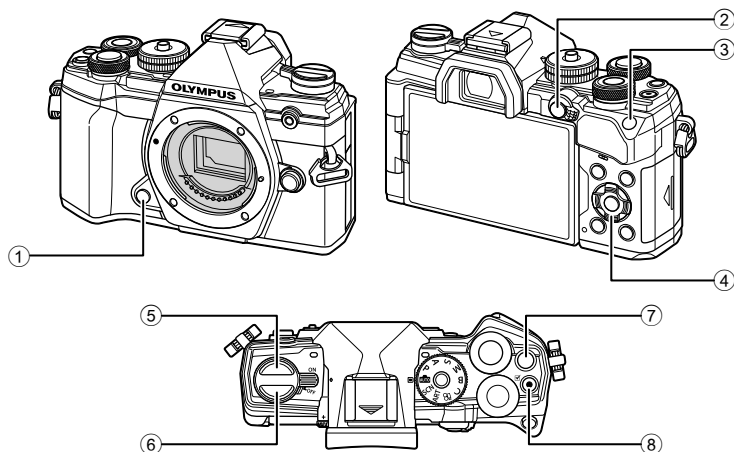
## Direct Buttons

Frequently-used photographic functions are assigned to buttons. These are referred to as “direct buttons”. Included are the buttons listed below, which can be used for basic shooting settings.



Direct button	Assigned function
① Preview button	Preview (P. 108)
② <b>AEL/AFL</b> button	AEL/AFL (P. 70)
③ <b>ISO</b> button	ISO sensitivity (P. 70)
④ Arrow pad	[::] (AF-target selection) (P. 65)
⑤  button	Sequential/self-timer shooting (P. 71)
⑥  ( <b>LV</b> ) button	Display (monitor/viewfinder) selection (P. 32)
⑦  button	Exposure compensation (P. 64)
⑧  button	Movie recording (P. 58)



- Buttons can be assigned different roles.  [📷 Button Function] (P. 107)

The exposure selected automatically by the camera can be altered to suit your artistic intent. Choose positive values to make pictures brighter, negative values to make them darker. Exposure compensation can be adjusted by up to  $\pm 5.0$  EV.



- Exposure compensation is available in modes **P**, **A**, **S**, **ART**, and . To enable exposure compensation in mode **M**, select [AUTO] for [ISO] (P. 70).







Negative (-)

No compensation (0)

Positive (+)

- Exposure compensation can be adjusted by up to  $\pm 5.0$  EV. The exposure bar in the display shows values of up to  $\pm 3.0$  EV. The bar flashes when a value outside this range is selected.
- The viewfinder and live view show the effects of values not exceeding  $\pm 3.0$  EV.
- To preview the effects of exposure compensation in live view, select [Off] for [Live View Boost] (P. 167) in  Custom Menu **D2**.
- During movie recording, exposure compensation can be adjusted by  $\pm 3.0$  EV.
- In movie mode, exposure compensation can be adjusted when [P], [A], or [S] is selected for  Mode] (movie exposure mode).
- The front and rear dials or touch controls can be used to adjust exposure during movie recording.

### ■ Access via the (Exposure Compensation) Button







Hold the  button and rotate the front or rear dial. You can also hold the  button and use the   buttons on the arrow pad.

- To reset exposure compensation, press and hold the  button.



Exposure compensation bar



-  (exposure compensation) can be assigned to other controls. Use the  Button Function] option (P. 107) in  Custom Menu **B** to choose the roles played by camera controls during still photography and the  Buttons/Dials/Lever] >  Button Function] (P. 145) option in the  movie menu to choose roles for movie recording.

### ■ Access via the Dials

In modes **P**, **A**, and **S**, exposure compensation can be adjusted using the front dial. Rotate the dial left or right. In mode **M**, hold the  button and rotate the front or rear dial.



## Choosing an AF Target Mode

(AF Target Mode)

Choose the size and shape of the AF target. You can also select Face priority AF (P. 67).

- 1 Use  $\Delta \nabla \triangleleft \triangleright$  to display the AF target.
- 2 Use the front dial during AF target selection to choose the target's size and shape.

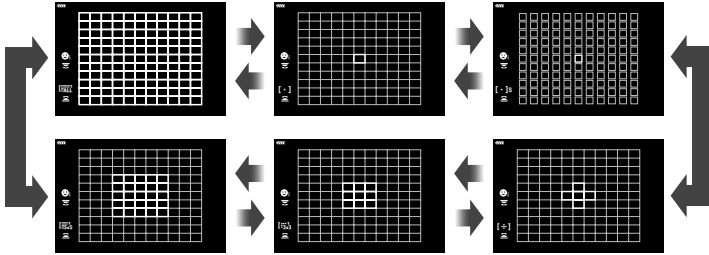

### [ · ] Single Target

Select a single focus target.

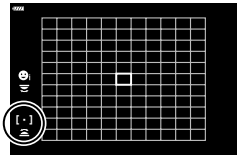

### [ · ]s Small Target

Further reduce the target size for single-target AF-target selection. Use for pinpoint focus on small subjects.

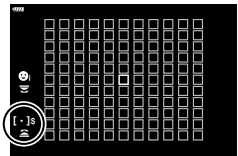

### [ · ] 5-Target Group

Select a group of 5 targets, arranged in a cross. The camera chooses the target used for focus from within the selected group.

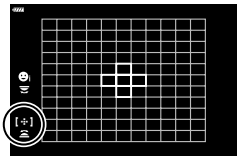

### [ · ] 9-Target Group (3 × 3)

Select a group of 9 targets, arranged in a square. The camera chooses the target used for focus from within the selected group.

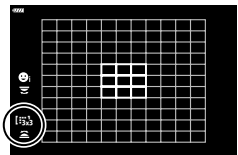

**25-Target Group (5 × 5)**

Select a group of 25 targets, arranged in a square. The camera chooses the target used for focus from within the selected group.

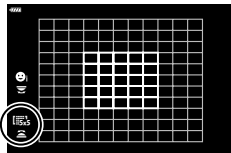
**All Targets (11 × 11)**

The camera chooses the target used for focus from all 121 targets.

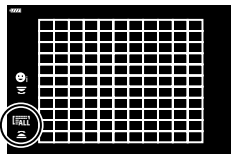

- The single target mode is automatically applied in movie shooting if the group target mode is set.



- You can adjust AF target settings for [C-AF]. [C-AF Center Start] (P. 177) and [C-AF Center Priority] (P. 178)
- To enable cluster AF targeting when (all targets) is selected and [S-AF], [S-AF MF], or [C-AF] is chosen for [AF Mode] (P. 80), select [On2] for [AF Area Pointer] (P. 162). The camera will display AF targets for all areas that are in focus.

**Choosing a Focus Target****(AF Target Point)**

The frame showing the location of the focus point is referred to as the "AF target". You can position the target over your subject.

- Use  $\Delta \nabla \triangleleft \triangleright$  to display the AF target.
- Use the arrow pad to position the AF target during AF target selection.



AF target

- The size and number of the AF target changes depending on the [Digital Tele-converter] (P. 130), [Image Aspect] (P. 87), and group target (P. 65) settings.
- Use the [Custom Settings] (P. 162) in the custom menus to choose the roles of the dials and  $\Delta \nabla \triangleleft \triangleright$  during AF target selection.

## Face priority AF/Eye priority AF

The camera automatically detects and focuses on the faces or eyes of portrait subjects. When digital ESP metering is used, exposure will be weighted according to the value metered for the face.

- 1 Use  $\Delta$   $\nabla$   $\triangleleft$   $\triangleright$  to display the AF target.
- 2 Use the rear dial to select an option during AF target selection.

Selected option

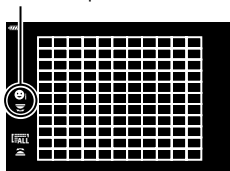

<b>Face Priority On</b>	The camera detects and focuses on faces.
<b>Face Priority Off</b>	Face priority AF off.
<b>Face &amp; Eye Priority On</b>	The camera detects faces and focuses on the eye closest to the camera.
<b>Face &amp; R. Eye Priority On</b>	The camera detects faces and focuses on the right eye.
<b>Face &amp; L. Eye Priority On</b>	The camera detects faces and focuses on the left eye.

- 3 Point the camera at your subject.
  - If a face is detected, it will be indicated by a white frame.

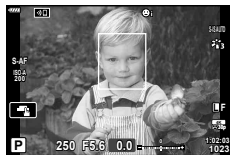

- 4 Press the shutter button halfway to focus.
  - The area of the subject used for focus is indicated by a green border.
  - If the camera detects the subject's eyes, it will focus on an eye.
  - A white border is also displayed if a face is detected during manual focus. Exposure will be set according to the value metered for the center of the face.



- 5 Press the shutter button the rest of the way down to shoot.
  - Depending on the subject and the art filter setting, the camera may not be able to correctly detect the face.
  - When set to (Digital ESP metering) (P. 82), metering is performed with priority given to faces.
  - Face priority is also available in [MF] (P. 80). Faces detected by the camera are indicated by white frames.
  - If the zoom frame is displayed, the camera will focus on the subject in the zoom frame.

## Zoom frame AF/Zoom AF

(Super Spot AF)

You can zoom in on the display during shooting. For greater precision during focusing, zoom in on the focus area. At higher zoom ratios, you can focus on areas smaller than the standard focus target. You can reposition the focus area as desired during zoom.

- To use Super Spot AF, you must first assign [Q] to a button with Button Function (P. 107).

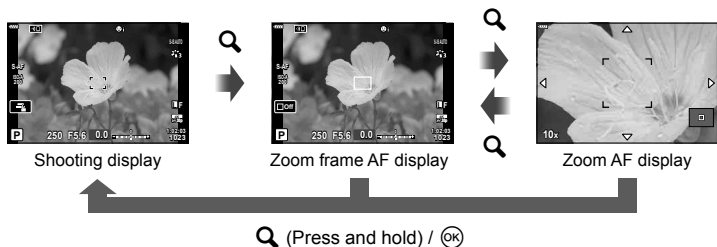

- 1 Press the button to which [Q] (magnify) is assigned.
  - The zoom frame will be displayed.
  - The frame is displayed in the same position as the target most recently used for autofocus.
- 2 Use  $\Delta \nabla \triangleleft \triangleright$  to position the zoom frame.
  - To re-center the frame, press and hold the  $\text{OK}$  button.
- 3 Adjust the size of the zoom frame to choose the zoom ratio.
  - Press the **INFO** button and then use the  $\Delta \nabla$  buttons or the front or rear dial to adjust the size of the zoom frame.
  - Press the  $\text{OK}$  button to accept and exit.

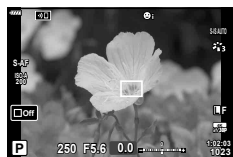

#### 4 Press the button to which [Q] is assigned once more.

- The camera will zoom the selected area in to fill the display.
- Use the front or rear dial to zoom in or out.
- You can also scroll the display using the arrow pad ( $\Delta \nabla \triangleleft \triangleright$ ).
- In shooting mode **M** (manual) or **B** (bulb), you can press the **INFO** button during zoom to choose aperture or shutter speed.
- Press the **Q** button to return to the zoom frame.
- Press the  $\odot$  button to end focus zoom.
- You can also end focus zoom by pressing and holding the **Q** button.



Exposure adjustment display for modes **M** and **B**

#### 5 Press the shutter button halfway to focus using autofocus.

- Focus zoom applies to the display only. Pictures taken with the camera are not affected.





- Touch controls can be used for focus zoom. "Shooting with touch screen operations" (P. 36)
- You can make the area in the zoom frame brighter for easier focus or configure the camera to exit focus zoom when the shutter button is pressed halfway to focus. [LV Close Up Settings] (P. 167)

## Changing ISO sensitivity (ISO)





Select a value according to subject brightness. Higher values let you photograph darker scenes but also increase image “noise” (mottling). Select [AUTO] to let the camera adjust sensitivity according to lighting conditions.

- 1 Press the **ISO** button, and rotate the front or rear dial to select a value.

<b>AUTO</b>	Sensitivity is adjusted automatically according to shooting conditions. Use [ISO-Auto Set] (P. 169) in  Custom Menu  to choose the maximum sensitivity selected by the camera and the shutter speed at which auto sensitivity control takes effect.
<b>LOW, 200–25600</b>	Choose a value for ISO sensitivity. ISO 200 offers a good balance between noise and dynamic range.

## Locking the exposure (AE Lock)









You can lock the exposure by pressing the **AEL/AFL** button. Use this when you want to adjust the focus and exposure separately or when you want to shoot several images at the same exposure.

- If you press the **AEL/AFL** button once, the exposure is locked and  is displayed.  
 “Setting Focus and Exposure with the **AEL/AFL** Button ( AEL/AFL)” (P. 175)
- Press the **AEL/AFL** button once again to release the AE Lock.
- The lock will be released if you operate the mode dial, **MENU** button, or  button.

## Performing the sequential/self-timer shooting









Adjust settings for burst or self-timer photography. Choose an option according to your subject.

- 1 Press the  button.
- 2 Rotate the front or rear dial to select a value.
  - Custom self-timer options can be viewed by pressing the **INFO** button.

 <b>Single</b>	Single-frame advance. The camera takes one photo each time the shutter button is pressed all the way down.
 <b>Sequential High</b>	The camera takes photos at up to about 10 fps while the shutter button is held all the way down. Focus, exposure, and white balance are locked at the values for the first shot in each series. You can choose the frame advance rate and the maximum number of shots in each series (P. 165). The frame advance rate drops at [ISO] settings over 8000.
 <b>Sequential Low</b>	The camera takes photos at up to about 6 fps while the shutter button is held all the way down. You can choose the frame advance rate and the maximum number of shots in each series (P. 165). Focus and exposure conform to the options selected for [AF Mode] (P. 80) and [AEL/AFL] (P. 175). If [C-AF] or [C-AF+TR] is selected for [AF Mode], the camera will focus before each shot. The frame advance rate drops at [ISO] settings over 8000.
 <b>12sec</b>	The shutter is released 12 s after the shutter button is pressed all the way down. The self-timer lamp will light for about 10 s and then start to flash about 2 s before the shutter is released. The camera focuses when the shutter button is pressed halfway.
 <b>2sec</b>	When the shutter button is pressed all the way down, the self-timer lamp will start to flash and a photo will be taken after about 2 seconds. The camera focuses when the shutter button is pressed halfway.
 <b>Custom Self-Timer</b>	Adjust self-timer settings, including the self-timer delay and the number of shots taken when the timer expires (P. 73).
 (sample icon) <b>Anti-Shock [♦]</b>	Reduce the slight blur caused by shutter motion. Available in single-frame, sequential low, and self-timer modes (P. 73).
 (sample icon) <b>Silent [♥]</b>	Take pictures with the electronic shutter. Use for shutter speeds faster than 1/8000 s or in settings where the sound of the shutter would be unwelcome. Available in single-frame, sequential low, sequential high, and self-timer modes. In ♥ mode, focus, exposure, and white balance are locked at the values for the first shot in each series. The flash sync speed is 1/50 s. At [ISO] settings over ISO 8000, the flash sync speed drops to 1/20 s.

<b>Pro Cap H</b>	<b>Pro Capture High*</b>	Capture starts when the shutter button is pressed halfway. The camera starts recording pictures, including those captured while the button was pressed halfway, when the button is pressed all the way down (P. 74). In <b>Pro Cap H</b> mode, focus, exposure, and white balance are locked at the values metered when the shutter button is pressed halfway.
<b>Pro Cap L</b>	<b>Pro Capture Low*</b>	
	<b>High Res Shot*</b>	Take high-resolution photos (P. 76). Use a tripod.

\* Art filter picture modes cannot be used.

- To cancel the activated self-timer, press  $\nabla$ .
- Fix the camera securely on a tripod for self-timer shooting.
- If you stand in front of the camera to press the shutter button when using the self-timer, the picture may be out of focus.
- In  and **Pro Cap L** modes, the camera displays the view through the lens during shooting. In  and **Pro Cap H** modes, it displays the shot immediately preceding the current frame.
- The speed of sequential shooting varies depending on the lens you are using and the focus of the zoom lens.
- During sequential shooting, if the battery level icon blinks due to low battery, the camera stops shooting and starts saving the pictures you have taken on the card. The camera may not save all of the pictures depending on how much battery power remains.
- You can choose the items displayed using [/Settings] in the custom menus (P. 166).
- Photographs taken in silent and pro-capture modes may be distorted if the subject or camera moves quickly during shooting.
- To use the flash in [Silent []] mode, select [Allow] for [Anti-Shock []/Silent []] > [Silent [] Mode Settings] > [Flash Mode] in  Shooting Menu 2.



## Self-Timer Options

## ( Custom Self-timer)

Adjust self-timer settings, including the shutter release delay and the number of shots taken when the timer expires.

- 1 Press the button.
- 2 Highlight (custom self-timer) by rotating the front or rear dial and press the **INFO** button.
- 3 Highlight items using on the arrow pad and use to choose an option.

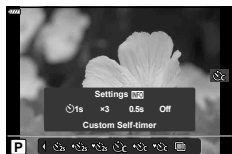

<b>Number of Frames</b>	Choose the number of shots taken when the timer expires.
<b>Timer</b>	Choose how long the camera waits to begin shooting after the shutter button is pressed all the way down.
<b>Interval Length</b>	Choose the interval between the shots taken when the timer expires.
<b>Every Frame AF</b>	Choose whether the camera focuses before each shot.

## Shooting without the vibration caused by shutter button operations (Anti-Shock [])

Reduce the slight blur caused by shutter motion.

Use this option when even slight camera motion can cause blur, for example during macro or telephoto photography.

You must first enable display of this option by selecting [ Settings] (P. 166) in Custom Menu **D1** and placing a check () next to the appropriate item.

The delay between the shutter button being pressed all the way down and the start of shooting can be selected using [Anti-Shock []/Silent []] > [Anti-Shock []] in Shooting Menu 2 (P. 142).

- 1 Press the button.
- 2 Select one of the items marked using the front or rear dial and press the button.
- 3 Take pictures.
  - When the set time has elapsed, the shutter is released and the picture is taken.

## Shooting without shutter sound

(Silent [♥])

In situations where the shutter sound is a problem, you can shoot without making a sound. An electronic shutter is used to reduce the minuscule camera shake caused by the motion of the mechanical shutter, much as is the case for anti-shock photography. The delay between the shutter button being pressed all the way down and the shutter being released can be selected using [Anti-Shock [♦]/Silent [♥]] > [Silent [♥]] in Shooting Menu 2 (P. 142).

- 1 Press the button.
- 2 Select one of the items marked ♥ using the front or rear dial and press the button.
- 3 Take pictures.
  - When the shutter is released, the monitor screen will go dark for a moment. No shutter sound will be emitted.
  - The desired results may not be achieved under flickering light sources such as fluorescent or LED lamps or if the subject moves abruptly during shooting.
  - The fastest available shutter speed is 1/32000 s.

## Shooting without a release time lag (Pro Capture shooting)

Capture starts when the shutter button is pressed halfway; the moment the button is pressed the rest of the way down, the camera will start saving the last  $n$  captured pictures to the memory card, where  $n$  is a number selected before shooting begins. If the button is held all the way down, shooting will continue until the selected number of pictures is recorded. Use this option to capture moments you might otherwise miss due to your subject's reactions or shutter lag. Choose from [Pro Capture Low] and [Pro Capture High].

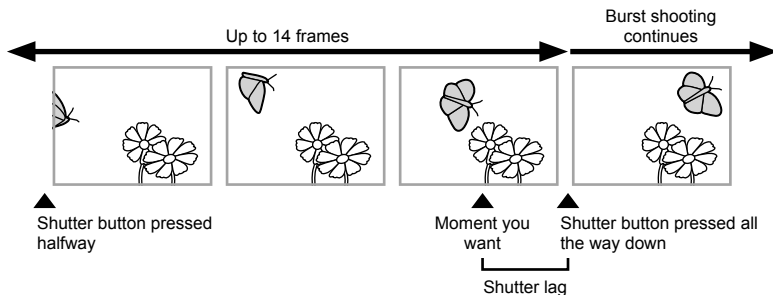





### Pro Capture Low (Pro Cap L)

The camera shoots at 10 fps. A maximum of 14 frames can be captured before the shutter button is pressed all the way down. If [C-AF] or [C-AF+TR] is selected for [AF Mode] (P. 80), the camera will focus before each shot. Choose this option if you anticipate that the distance to the subject will change during shooting.

### Pro Capture High (Pro Cap H)

The camera shoots at up to 30 fps. A maximum of 14 frames can be captured before the shutter button is pressed all the way down. The camera will use [S-AF] when [C-AF] or [C-AF+TR] is selected for [AF Mode] (P. 80). Choose this option if the distance to the subject is unlikely to change very much during shooting.

- 1 Press the  button.
- 2 Select Pro Cap H (Pro Capture High) or Pro Cap L (Pro Capture Low) using the front or rear dial and press the  button.
- 3 Take pictures.

- Capture starts when the shutter button is pressed halfway. A capture icon () will be displayed. If the button is kept pressed halfway for over a minute, capture will end and the  icon will clear from the display. Press the shutter button halfway again to resume shooting.
- Press the shutter button all the way down to start saving pictures to the memory card.
- Shooting will continue while the shutter button is pressed all the way down, up to the number of shots selected for [Frame Count Limiter].

Capture icon







- Selecting Pro Cap L (Pro Capture Low) restricts aperture to values between maximum aperture and f8.0.
- Four Thirds and third-party Micro Four Thirds lenses cannot be used in Pro Cap L (Pro Capture Low) mode.
- Flickering occurred by fluorescent lights or the large movement of the subject, etc. may cause distortions in images.
- During capture, the monitor will not go dark and the sound of the shutter will not be heard.
- The slowest shutter speed is limited.
- [Max fps] (Pro Cap H/Pro Capture High only), [Pre-shutter Frames], and [Frame Count Limiter] can be adjusted via the custom menus using the [L Settings] and [H Settings] [Pro] options (P. 182).

## Shooting still pictures in a higher resolution (High Res Shot)

Shoot at resolutions higher than that of the image sensor. The camera takes a series of shots while moving the image sensor and combines them to create a single high-resolution photo. Use this option to capture details that normally would not be visible even at high zoom ratios. Take steps to steady the camera, for example by mounting it on a tripod.





Use the [High Res Shot] option (P. 143) in  Shooting Menu 2 to choose time between the shutter button being pressed all the way down and the shutter being released, as well as the time allocated for the flash to charge when a flash is used in High Res Shot mode.

After setting high resolution shooting, you can select the image quality of the high resolution shooting using image quality mode (P. 88, 129).

- 1 Press the  button.
- 2 Select  using the front or rear dial and press the  button.
  - A  icon will be displayed. The icon will flash if the camera is not steady. The icon stops flashing when the camera is steady and ready to shoot.
  - After enabling High Res Shot, check the option selected for image quality. Image quality can be adjusted in the LV super control panel.



Camera readying for High Res Shot (flashes)

- 3 Take pictures.
  - The  will flash to warn that shots may be blurred by camera shake. Keep the camera steady.
  - Shooting is complete when the green  icon clears from the display.
  - The camera will automatically create the composite image when shooting is complete. A message will be displayed during this process.
- Choose from JPEG ( or ) and JPEG+RAW modes. When image quality is set to RAW+JPEG, the camera saves a single RAW image (extension ".ORI") before combining it with the high resolution shooting. Pre-combination RAW images can be played back using the latest version of Olympus Workspace.
-  Image Stabilizer (P. 86) is set to [S-IS Off].
- During RC flash photography, the maximum flash wait time is 4 s and the flash control mode is fixed at MANUAL.
- High Res Shot is available in modes **P**, **S**, **A**, and **M**.
- The following cannot be used:
  - interval-timer photography, multiple exposure, keystone compensation, bracketing, fisheye correction, and HDR.
- Pictures taken with [e-Portrait] or an art filter selected for picture mode will be recorded in [Natural] mode.
- Image quality may drop under flickering light sources such as fluorescent or LED lamps.
- Definition may be lost in areas of the picture where objects moved during shooting.

## The Super Control/LV Super Control Panel

The super control/LV super control panel lists shooting settings and their current values. Use the LV super control panel when framing shots in the monitor ("live view"), the super control panel when framing shots in the viewfinder.

- Pressing the  (LV) button during live view enables viewfinder photography and displays the LV super control panel in the monitor.

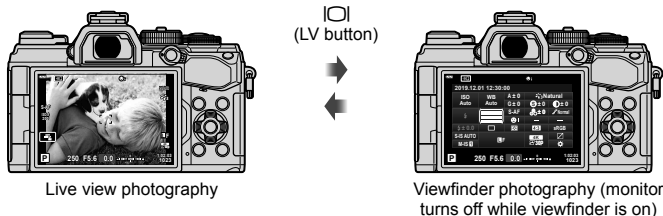

### LV Super Control Panel (Live View Photography)

To display the LV super control panel in the monitor, press the  button during live view.



### Super Control Panel (Viewfinder Photography)

When you frame subjects in the viewfinder, the super LV control panel will be displayed in the monitor at all times. Press the  button to activate the cursor.



## ■ Using the Super Control/LV Super Control Panel

- 1 Press the **OK** button.
  - If you press the button during live view, the LV super control panel will be displayed in the monitor.
  - The last setting used will be highlighted.

Cursor



- 2 Highlight an item using  $\Delta$   $\nabla$   $\triangleleft$   $\triangleright$  on the arrow pad or by rotating the rear dial.
  - The selected setting will be highlighted.
  - You can also highlight items by tapping them in the display.

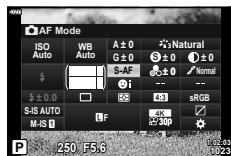
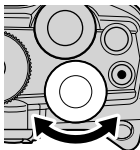

- 3 Rotate the front dial to change the highlighted setting.
  - The selected setting will be highlighted.

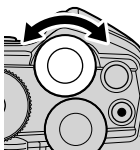

- 4 Press the shutter button halfway to accept current settings and exit the LV super control panel.
  - If you are using the super control panel, the cursor will vanish and setting will end.

### Additional Options

Pressing the **OK** button in Step 2 displays options for the highlighted setting. In some cases, additional options can be viewed by pressing the **INFO** button.

INFO button

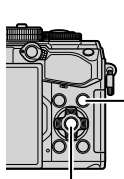

OK button



INFO

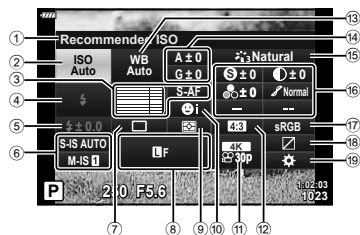

 Image Stabilizer

- Touch controls can be used in place of the **OK** button. Lightly tap the desired setting twice to display options.

## ■ Settings Available in the Super Control/LV Super Control Panel

### LV super control panel



- ① Currently selected option
- ② ISO sensitivity.....P. 80
- ③ AF mode.....P. 80  
AF target.....P. 65
- ④ Flash mode.....P. 93
- ⑤ Flash intensity control.....P. 97
- ⑥ Image stabilizer.....P. 86
- ⑦ Sequential shooting/Self-timer.....P. 87
- ⑧ .....P. 88
- ⑨ Metering mode.....P. 82
- ⑩ Face priority.....P. 67
- ⑪ .....P. 89
- ⑫ Aspect ratio.....P. 87
- ⑬ White balance.....P. 83

\*1 Displayed when Partial Color is set.

\*2 Displayed when Color Creator is set.

\*3 Displayed when an art filter is selected.

### Super control panel

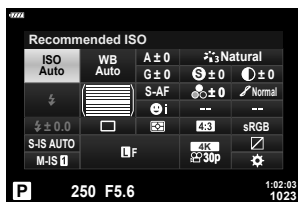

- ⑭ White balance compensation/  
Color temperature.....P. 85
- ⑮ Picture mode.....P. 98
- ⑯ Sharpness .....P. 101  
Contrast .....P. 101  
Saturation .....P. 101  
Gradation .....P. 102  
Color filter .....P. 103  
Monochrome color .....P. 104  
Effect .....P. 104  
Color\*<sup>1</sup>.....P. 56  
Color/Vivid\*<sup>2</sup>.....P. 100  
Effect\*<sup>3</sup>.....P. 98
- ⑰ Color space.....P. 105
- ⑱ Highlight & shadow control.....P. 106
- ⑲ Button function assignment.....P. 107

## Changing ISO sensitivity

(ISO)

You can set the ISO sensitivity.

☞ “Changing ISO sensitivity (ISO)” (P. 70)

- 1 Press the **OK** button to display the LV super control panel.
- 2 Use **Δ ▽ < >** to select [ISO].
- 3 Use the front dial to select an option.

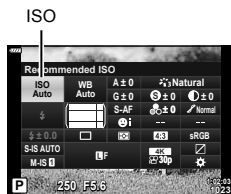

## Choosing a focus mode

(AF Mode)

You can select a focusing method (focus mode). You can choose separate focusing methods for still photography mode and movie mode.

- 1 Press the **OK** button to display the LV super control panel.
- 2 Use **Δ ▽ < >** to select [AF Mode].
- 3 Use the front dial to select an option.

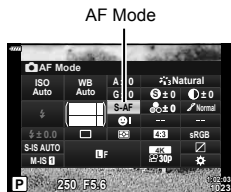

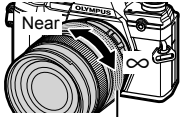

<b>S-AF</b> (Single AF)	The camera focuses once when the shutter button is pressed halfway. When the focus is locked, a beep sounds, and the AF confirmation mark and the AF target mark light up. This mode is suitable for taking pictures of still subjects or subjects with limited movement.
<b>C-AF</b> (Continuous AF)	The camera repeats focusing while the shutter button remains pressed halfway. When the subject is in focus, the AF confirmation mark lights up on the monitor and the beep sounds when the focus is locked at the first time. Even if the subject moves or you change the composition of the picture, the camera continues trying to focus.
<b>MF</b> (Manual focus)	This function allows you to manually focus on any position by operating the focus ring on the lens. <div style="text-align: right;">  </div>
<b>S-AF MF</b> (Simultaneous use of S-AF mode and MF mode)	After pressing the shutter button halfway to focus in [S-AF] mode, you can turn the focus ring to fine-adjust focus manually.



<b>C-AF TR</b> (AF tracking)	Press the shutter button halfway to focus; the camera then tracks and maintains focus on the current subject while the shutter button is held in this position. <ul style="list-style-type: none"> <li>• The AF target is displayed in red if the camera can no longer track the subject. Release the shutter button and then frame the subject again and press the shutter button halfway.</li> <li>• Autofocus does not work while the AF target is displayed in red even if the camera is tracking the subject.</li> </ul>
<b>PreMF</b> (Preset MF)	The camera automatically focuses on the preset focus point when shooting.

- The camera may be unable to focus if the subject is poorly lit, obscured by mist or smoke, or lacks contrast.
- When using a Four Thirds system lens, AF will not be available during movie recording.
- AF-mode selection is not available if the lens MF clutch is set to the MF position and [Operative] is selected for [MF Clutch] (P. 163) in Custom Menu.

### Setting a focus position for PreMF

- 1 Select [Preset MF] for AF mode.
- 2 Press the  button and then the **INFO** button.
- 3 Press the shutter button halfway to focus.
  - Focus can be adjusted by rotating the focus ring.
- 4 Press the  button.
  - The PreMF function can be recalled by pressing the button to which [Preset MF] is assigned in [📷 Button Function]. Press the button again to return to the original AF.
  - The distance for the preset focus point can be set with [Preset MF distance] in Custom Menu (P. 163).





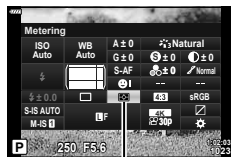

## Choosing how the camera measures brightness (Metering)

You can choose how the camera meters subject brightness.

- 1 Press the **OK** button to display the LV super control panel.
- 2 Use **△ ▽ ◀ ▶** to select [Metering].
- 3 Use the front dial to select an option.



Metering

 <b>Digital ESP metering</b>	Meters exposure in 324 areas of the frame and optimizes exposure for the current scene or portrait subject (if an option other than [OFF] is selected for [☺ Face Priority]). This mode is recommended for general use.	
 <b>Center weighted averaging metering</b>	Provides the average metering between the subject and the background lighting, placing more weight on the subject at the center.	
 <b>Spot metering</b>	Meters a small area (about 2% of the frame) with the camera pointed at the object you wish to meter. Exposure will be adjusted according to the brightness at the metered point.	
 <b>Spot metering (highlight)</b>	Increases spot metering exposure. Ensures bright subjects appear bright.	
 <b>Spot metering (shadow)</b>	Lowers spot metering exposure. Ensures dark subjects appear dark.	

- The spot metering position can be set at the selected AF target.  **[[:]] Spot Metering** (P. 170)

## Adjusting color

## (WB (white balance))

White balance (WB) ensures that white objects in images recorded by the camera appear white. [AUTO] is suitable in most circumstances, but other values can be selected according to the light source when [AUTO] fails to produce the desired results or you wish to introduce a deliberate color cast into your images.

- 1 Press the **OK** button to display the LV super control panel.
- 2 Use  $\Delta \nabla \triangleleft \triangleright$  to select [WB].
- 3 Use the front dial to select an option.
  - One-touch white balance and custom white balance options can be viewed by pressing the **OK** button followed by the **INFO** button.

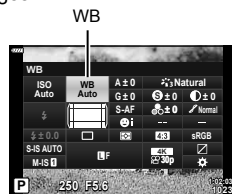

WB mode		Color temperature	Light conditions
Auto white balance	AUTO	—	Most normal scenes (scenes containing objects that are white or close to white) <ul style="list-style-type: none"> <li>• This mode is recommended in most situations.</li> <li>• You can opt to preserve the colors seen under incandescent lighting (P. 84).</li> </ul>
Preset white balance		5300 K	Sunlit outdoor scenes, sunsets, fireworks
		7500 K	Daylight shots of subjects in the shade
		6000 K	Shots taken in daylight under overcast skies
		3000 K	Subjects under incandescent lighting
		4000 K	Subjects under fluorescent lighting
		—	Underwater photography
One-touch white balance		5500 K	Light sources with the same color temperature as flash lighting
		Color temperature set by one-touch WB	Situations in which you want to set white balance for a specific subject <ul style="list-style-type: none"> <li>• Color temperature is set to a value metered from a white object under the lighting what will be used in the final photograph (P. 84).</li> </ul>
Custom white balance	CWB	2000 K–14000 K	Situations in which you can identify the appropriate color temperature <ul style="list-style-type: none"> <li>• Choose a color temperature.</li> </ul>

**One-touch white balance**

Measure white balance by framing a piece of paper or other white object under the lighting that will be used in the final photograph. This is useful when shooting a subject under natural light, as well as under various light sources with different color temperatures.

- 1 After selecting [WB1], [WB2], [WB3], or [WB4] (one-touch white balance 1, 2, 3, or 4), press the **OK** button followed by the **INFO** button.
- 2 Photograph a piece of colorless (white or gray) paper.
  - Frame the paper so that it fills the display and no shadows fall it.
  - The one-touch white balance screen appears.
- 3 Select [Yes] and press the **OK** button.
  - The new value is saved as a preset white balance option.
  - The new value is stored until one-touch white balance is measured again. Turning the power off does not erase the data.

**<sup>WB</sup><sub>AUTO</sub> Keep Warm Color**

If desired, auto white balance can be adjusted to preserve the warm colors seen under incandescent lighting. White balance would normally be adjusted to make white colors appear white, but this feature can be used to preserve the ambiance created by incandescent lighting.

- 1 After selecting [AUTO], press the **OK** button followed by the **INFO** button.
  - [<sup>WB</sup><sub>AUTO</sub> Keep Warm Color] options will be displayed.
- 2 Highlight [On] using  $\Delta$   $\nabla$   $\triangleleft$   $\triangleright$  on the arrow pad and press the **OK** button.

## Making fine adjustments to white balance (WB Compensation)

Choose white balance compensation values to fine-tune auto white balance, preset white balance, and one-touch white balance.

- 1 Press the **OK** button to display the LV super control panel.
- 2 Use **△ ▽ <|>** to select [WB].
- 3 Use the front dial to select an option.
- 4 Use **△ ▽ <|>** to select the white balance compensation.
- 5 Change the white balance compensation value using the front dial.
  - Pressing **OK** displays hue adjustment options.

White balance compensation



### For compensation on the A axis (Red-Blue)

Move the bar in the + direction to emphasize red tones and in the – direction to emphasize blue tones.

### For compensation on the G axis (Green-Magenta)

Move the bar in the + direction to emphasize green tones and in the – direction to emphasize magenta tones.

- White balance compensation can be applied to all white balance modes simultaneously.  
 [All **WBZ**] (P. 171)



- To preview the effects of changes to white balance, press the **Movie** button. A sample image captured at the selected white balance will be displayed.

## Reducing camera shake

## (Image Stabilizer)

You can reduce the amount of camera shake that can occur when shooting in low light situations or shooting with high magnification.

The image stabilizer starts when you press the shutter button halfway.

- 1 Press the **OK** button to display the LV super control panel.
- 2 Use **△ ▽ ◀ ▶** to select the image stabilizer.
- 3 Use the front dial to select an option.

 Image Stabilizer

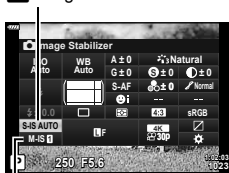



 Image Stabilizer

Still picture (S-IS)	S-IS Off	Still-I.S. Off	Image stabilization disabled. Select this option when using a tripod.
	S-IS AUTO	Auto I.S.	Image stabilization applies to motion on all axes. If panning motion is detected, the camera will automatically suspend image stabilization on that axis.
	S-IS <b>1</b>	All Direction Shake I.S.	Image stabilization applies to motion on all axes.
	S-IS <b>2</b>	Vertical Shake I.S.	Image stabilization applies to vertical motion. Use when panning the camera horizontally.
	S-IS <b>3</b>	Horizontal Shake I.S.	Image stabilization applies to horizontal motion. Use when panning the camera vertically.
Movie (M-IS)	M-IS Off	Movie-I.S. Off	Image stabilizer is off.
	M-IS <b>1</b>	All Direction Shake I.S.	Electronic image stabilization combined with VCM-controlled image sensor movement.
	M-IS <b>2</b>	All Direction Shake I.S.	VCM-controlled image sensor movement only.

- Image stabilization may be unable to compensate for excessive camera motion or very slow shutter speeds. Use a tripod in these cases.
- You may notice noise or vibration while image stabilization is in effect.
- The setting selected with the lens image stabilization switch, if any, takes priority over that selected with the camera.



- You can choose whether image stabilization will be performed while the shutter button is pressed halfway.  [Half Way Rls With IS] (P. 165)
- You can prioritize lens image stabilization.  [Lens I.S. Priority] (P. 165)

## Using lenses other than Micro Four Thirds/Four Thirds System lenses

When using lenses other than Micro Four Thirds or Four Thirds system lenses, you will need to specify the lens focal length.

- Set [Image Stabilizer], press the **OK** button, press the **INFO** button, then use  $\Delta \nabla \langle \rangle$  to select a focal length, and press the **OK** button.
- Choose a focal length between 0.1 mm and 1000.0 mm.
- Choose the value that matches the one printed on the lens.
- The selected value is not reset when you select [Reset / Custom Modes] (P. 127) > [Reset] (basic) in  $\square$  Shooting Menu 1.

## Performing the sequential/self-timer shooting

You can take a series of pictures by keeping the shutter button pressed all the way down. Alternatively, you can take pictures using the self-timer.

$\square$  “Performing the sequential/self-timer shooting” (P. 71–76)

- 1 Press the **OK** button to display the LV super control panel.
- 2 Use  $\Delta \nabla \langle \rangle$  to select the sequential shooting/self-timer.
- 3 Use the front dial to select an option.

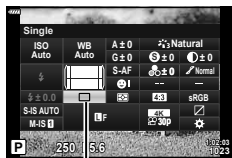

Sequential shooting/  
self-timer

## Setting the image aspect

Choose the ratio of width to height for pictures according to your intent or your goals for printing or the like. In addition to the standard aspect (width-to-height) ratio of [4:3], the camera offers settings of [16:9], [3:2], [1:1], and [3:4].

- 1 Press the **OK** button to display the LV super control panel.
- 2 Use  $\Delta \nabla \langle \rangle$  to select [Aspect].
- 3 Use the front dial to select an option.



Aspect

- Image aspect can only be set for still images.
- JPEG images are recorded at the selected aspect ratio. RAW images are the same size as the image sensor and are recorded at an aspect ratio of 4:3 with a tag indicating the aspect ratio selected. A crop indicating the selected aspect ratio is displayed when images are played back.

## Photo File and Image Size Options



You can set an image quality mode for still images. Select a quality suitable for the application (such as for processing on PC, use on website etc.).

- 1 Press the **OK** button to display the LV super control panel.
- 2 Use **Δ** **∇** **<** **>** to select [**📷** **☰**].



- 3 Use the front dial to select an option.

- Choose from the following options. The image size/compression combinations available can be selected in the menus. **📷** **⚙️** Custom Menu **G** > [**☰** Set] (P. 196)

Option	Image size	Compression ratio	File format
<b>SF</b>	5184 × 3888	SuperFine (1/2.7)	JPG
<b>F</b>	5184 × 3888	Fine (1/4)	JPG
<b>N</b>	5184 × 3888	Normal (1/8)	JPG
<b>MN</b>	3200 × 2400	Normal (1/8)	JPG
<b>RAW</b>	5240 × 3192	Lossless compression	ORF
<b>RAW+JPEG</b>	RAW plus the JPEG option selected above		

- During the high resolution shooting (P. 76), you can select between **50M F**, **25M F**, **50M F+RAW**, and **25M F+RAW**.
- Selecting High Res Shot changes the image quality option selected; be sure to check the image quality setting before shooting.





- RAW images consist of unprocessed image data to which settings such as exposure compensation and white balance have yet to be applied. They serve as raw data for images that will be processed after shooting. RAW image files:
  - Have the extension “.orf”
  - Cannot be viewed on other cameras
  - Can be viewed on computers using Olympus Workspace Digital Photo Managing software
  - Can be saved in JPEG format using the [RAW Data Edit] (P. 153) retouch option in the camera menus



## Frame Size, Rate, and Compression



Choose the image quality options available for movie recording. When choosing an option, consider how the movie will be used: for example, are you planning to process it on a computer, or is it intended for upload to a website? The camera can store multiple combinations of frame size, rate, and compression from which you can select according to your goals. Slow- and fast-motion and high-speed movie options are also available.  “Filming Slow- or Fast-Motion Movies (Slow- and Fast-Motion Movies)” (P. 92) and “Filming High-Speed Movies” (P. 91)

**1** Press the  button to display the LV super control panel.

**2** Use     to select .

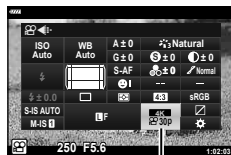

**3** Use the front dial to select an option.

- To change movie record mode settings, press  followed by the **INFO** button and rotate the rear dial.

## The Movie Quality Icon

Changes to settings are reflected in the  icon as shown below.



**Frame size**

<b>FHD</b>	Full HD* <sup>1</sup>	1920 × 1080
<b>HD</b>	HD* <sup>1</sup>	1280 × 720
<b>4K</b>	4K* <sup>1</sup>	3840 × 2160
<b>C4K</b>	4K Digital Cinema* <sup>1</sup>	4096 × 2160



**Compression/bit rate**

<b>A-I</b>	All Intra* <sup>2</sup>	<ul style="list-style-type: none"> <li>• Not available when [4K] or [C4K] is selected for [Movie Resolution].</li> </ul>
<b>SF</b>	Super Fine	
<b>F</b>	Fine	
<b>N</b>	Normal	

**Frame rate**

<b>60p</b>	60p: 59.94 fps	<ul style="list-style-type: none"> <li>• [60p] and [50p] are not available when:               <ul style="list-style-type: none"> <li>- [FHD] is selected for [Movie Resolution] and [A-I] is selected for bit rate</li> <li>- [4K] or [C4K] is selected for [Movie Resolution]</li> </ul> </li> <li>• Selecting [C4K] for [Movie Resolution] fixes [Frame Rate] at [24p].</li> </ul>
<b>50p</b>	50p: 50.00 fps	
<b>30p</b>	30p: 29.97 fps	
<b>25p</b>	25p: 25.00 fps	
<b>24p</b>	24p: 23.98 fps 24p: 24.00 fps (C4K)	

**Movie type**

	Setting 1, 2, 3, or 4: Save up to four combinations of frame size, rate, and compression for later use.
	Custom: Choose frame sizes of 4K or 4K Digital Cinema. You can also shoot fast- or slow-motion movies (P. 92).
—	High-speed movie  "Filming High-Speed Movies" (P. 91)

\*1 Movies are saved in MPEG-4 AVC/H.264 format. Individual movie files can be up to 4 GB in size. Continuous shots can be no more than 29 minutes in length.

\*2 "All-Intra" movies use no inter-frame compression. This suits them to editing but increases file size.

- Depending on the card used, recording may end before the maximum length is reached.
- Bit-rate selection may be unavailable at some settings.
- Movies are recorded at an aspect ratio of 16:9. C4K movies are recorded at an aspect ratio of 17:9.

## Filming High-Speed Movies

Film at high frame rates. Movies are filmed at 120 fps and play back at 60 fps. Stretching playback to double the recording time (as is the case when 60p is selected as the playback frame rate) lets you view in slow motion movements that in real life took only the blink of an eye.

A high-speed movie option can be included in the movie image quality menu. Your choice of playback frame rate determines the playback speed multiplier.

Changes to settings are reflected in the movie quality icon as shown.

	<b>Frame size</b>	FHD Full HD (1920 × 1080)
	<b>Movie type</b>	HS High speed (120 fps)
	<b>Playback frame rate</b>	60p 60p: 59.94 fps; plays back at 0.5× speed
		50p 50p: 50.00 fps; plays back at 0.42× speed
		30p 30p: 29.97 fps; plays back at 0.25× speed
		25p 25p: 25.00 fps; plays back at 0.21× speed
		24p 24p: 23.98 fps; plays back at 0.2× speed

- Select **FHD HS 60p** (high-speed movie recording).
  - To use current settings, press the **OK** button. The camera will exit the menu with the current options selected.
- To edit current settings, press the **INFO** button in Step 1.
  - This places the cursor in the list of high-speed movie options.
- Choose the playback frame rate.
  - Use **Δ** **▽** on the arrow pad to highlight the desired playback frame rate.
- Press the **OK** button to select the highlighted option and exit.
  - Focus, exposure, and white balance lock during recording.
  - Sound is not recorded.
  - The picture angle is slightly reduced.
  - Aperture, shutter speed, exposure compensation, and ISO sensitivity cannot be changed during recording.
  - Time codes cannot be recorded or displayed.
  - Brightness may change if zoom is adjusted during recording.
  - Individual movies can be up to 4 GB in size.
  - High-speed movie recording is not available while the camera is connected to an HDMI device.
  - [Image Stabilizer] > [M-IS] is not available.
  - Movie effects cannot be used.
  - [i-Enhance], [e-Portrait], and art filter picture modes are not available.
  - [Gradation] is fixed at [Gradation Normal].
  - High-speed movie recording is not available during remote photography when the camera is connected to a smartphone.

## Filming Slow- or Fast-Motion Movies

### (Slow- and Fast-Motion Movies)

You can create slow motion or fast-motion movies. You can set the recording speed using in record mode.

- 1 Press the button to display the LV super control panel.
  - 2 Use to select [ ].
  - 3 Use the front dial to select (custom record mode) (P. 90), then press the button.
    - The option selected for [Slow or Fast Motion] can be changed by pressing the **INFO** button. In , select [Slow or Fast Motion] and then press to select a magnification factor and press the button. Increase the multiplication factor to shoot a fast-motion movie. Reduce the multiplication factor to shoot a slow motion movie. The frame rate changes accordingly.
  - 4 Press the button to start shooting.
    - Press the button again to end shooting.
    - The movie will be played back at a fixed speed so that it appears to be in slow motion or fast-motion.
- Sound will not be recorded.
  - Any picture mode art filters will be canceled.
  - Either or both of slow motion and fast-motion cannot be set for some options of [ ].
  - Shutter speed is limited to values no slower than 1/24 s. The slowest speed available varies with the option selected for [Frame Rate].



## Using a flash

## (Flash photography)

When using a flash unit designed for use with the camera, you can choose the flash mode using camera controls and take pictures with the flash.

### ■ Attaching Compatible Flash Units

The methods used to attach and operate external flash units vary with the unit. See the documentation provided with the unit for details. The instructions here apply to the FL-LM3.

- Confirm that both the camera and flash unit are off. Attaching or removing a flash unit while either the camera or flash unit is on could damage the equipment.

#### 1 Remove the hot shoe cover and attach the flash.

- Slide the flash in until the foot clicks into place at the back of the shoe.

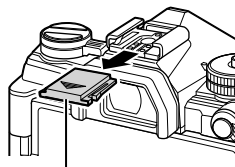

Hot shoe cover

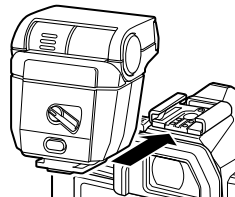

#### 2 Position the flash head for bounce-flash photography or direct lighting.

- The flash head can be rotated up and left or right.
- Note that flash output may be insufficient for correct exposure when bounce flash lighting is used.

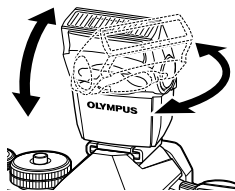

#### 3 Rotate the flash **ON/OFF** lever to the **ON** position.

- Rotate the lever to the **OFF** position when the flash is not in use.



**ON/OFF** lever

## ■ Removing Flash Units

- 1 Keeping the **UNLOCK** button pressed, slide the flash unit from the hot shoe.



**UNLOCK** button

## Choosing a Flash Mode

(Flash Mode)

When taking pictures with a flash unit designed for use with the camera, you can select a flash mode using camera controls. Turning an attached flash unit on automatically limits the fastest available shutter speed.

- 1 Press the **OK** button to display the LV super control panel.
- 2 Use **Δ** **▽** **<** **>** to select [Flash Mode].

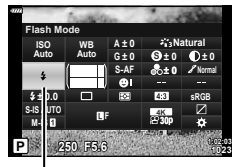





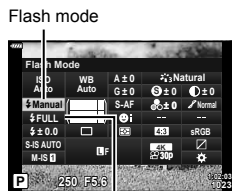











Flash mode



- 3 Use the front dial to select an option.
  - Flash settings can be accessed via the LV super control panel.



Flash output



## ■ Flash Modes















 <b>Fill In</b>	<p>Enable the flash.</p> <ul style="list-style-type: none"> <li>Shutter speed can be set to values between that selected for [ Slow Limit] (P. 170) and [ X-Sync.] (P. 170) in  Custom Menu .</li> </ul>
 <b>Flash Off</b>	<p>Disable the flash.</p> <ul style="list-style-type: none"> <li>The flash will not fire even if the unit is on.</li> </ul>
 <b>Redeye</b>	<p>Reduce “red-eye” in portrait photos. In other respects, the flash functions as it does in  (fill in) mode.</p>
 <b>Slow</b> (slow front-curtain sync)	<p>Slow shutter speeds are used to capture both the main subject and the background.</p> <ul style="list-style-type: none"> <li>Shutter speed is set according to the exposure value metered by the camera and is not restricted by the option selected for [ Slow Limit].</li> </ul>
 <b>Red-Eye Slow</b>	<p> (slow sync) combined with red-eye reduction. The flash is timed using front-curtain sync.</p>
 <b>Slow2</b> (slow rear-curtain sync)	<p>As for  (slow sync).</p> <ul style="list-style-type: none"> <li>The flash fires immediately before the shutter closes. Moving objects appear to leave trails of light behind them.</li> </ul> 
 FULL,  1/4, etc. <b>Manual Value</b>	<p>The flash fires at the selected level.</p>

- Super FP high-speed sync must be configured using flash controls.
- In [] (red-eye reduction) mode, the shutter is released approximately one second after the first red-eye reduction flash. Do not move the camera until shooting is complete.
- [] (red-eye reduction) may not produce the desired results in some conditions.

## ■ Flash Mode and Shutter Speed

The range of shutter speeds available varies with the flash mode. The range of available speeds can be further restricted using the options in the  custom menu.

 [X-Sync.] (P. 195), [ Slow Limit] (P. 195)

Exposure mode	LV super control panel	Flash mode	Flash timing	Shutter speed
P/A		Fill flash	Front-curtain sync	30–1/250 s
		Red-eye		
		Flash off	—	—
		Red-eye slow	Front-curtain sync	60–1/250 s
		Slow front-curtain sync		
		Slow rear-curtain sync	Rear-curtain sync	
S/M		Fill flash	Front-curtain sync	
		Red-eye		
		Flash off	—	—
		Slow rear-curtain sync	Rear-curtain sync	60–1/250 s
	B*		Fill flash	Front-curtain sync
		Red-eye		
		Flash off	—	—
		Slow rear-curtain sync	Rear-curtain sync	—

\* Rear-curtain sync is not available when [LIVE COMP] is selected (P. 47).

- The fastest shutter speed available when the flash fires is 1/250 s. Bright backgrounds in pictures taken with the flash may be overexposed.
- The flash sync speed for silent modes (P. 74), High Res Shot (P. 76), and focus bracketing (P. 134) is 1/50 s. Setting [ISO] to a value over ISO 8000 when using an option that requires the electronic shutter (for example, silent mode or focus bracketing) sets the flash sync speed to 1/20 s. The flash sync speed is also set to 1/20 s during ISO bracketing (P. 133).
- Even the minimum available flash output may be too bright at short range. To prevent overexposure in pictures taken at short range, select mode **A** or **M** and choose a smaller aperture (higher f-number) or choose a lower setting for [ISO].



## Adjusting flash output (Flash intensity control)

Flash output can be adjusted if you find that your subject is overexposed, or is underexposed even though the exposure in the rest of the frame is appropriate.

Flash compensation is available in modes other than [Manual] (manual).

- When [Manual] is selected, you can adjust flash output by pressing  $\nabla$  to select [FULL] and then rotating the front dial.

- 1 Press the  $\text{OK}$  button to display the LV super control panel.
- 2 Use  $\Delta \nabla \triangleleft \triangleright$  to select [Flash].
- 3 Use the front dial to select an option.





























- Changes to flash intensity made with the external flash unit are added to those made with the camera.

Choose how pictures are processed during shooting to enhance color, tone, and other properties. Choose from preset picture modes according to your subject or artistic intent. Contrast, sharpness, and other settings can be adjusted separately for each mode. You can also add artistic effects using art filters. Art filters give you the option of added frame effects and the like. Adjustments to individual parameters are stored separately for each picture mode and art filter.

- This item applies during both still photography and movie recording.

### Picture mode options

 <b>i-Enhance</b>	The camera adjusts colors and contrast for optimal results according to the type of subject (P. 104).
 <b>Vivid</b>	Choose for vivid colors.
 <b>Natural</b>	Choose for natural colors.
 <b>Muted</b>	Choose for pictures that will later be retouched.
 <b>Portrait</b>	Enhance skin tones.
 <b>Monochrome</b>	Record pictures in monochrome. You can apply color filter effects and choose a tint (P. 104).
 <b>Custom</b>	Adjust picture mode parameters to create a custom version of a selected picture mode.
 <b>e-Portrait</b>	Smooth complexions.
 <b>Underwater</b>	Process pictures to preserve the vivid colors seen under water. • We recommend choosing [Off] for [WB] (P. 170) when this option is selected.
 <b>Color Creator</b>	Adjust hue and color to suit your creative intent (P. 100).
 <b>Pop Art</b>	Uses Art Filter settings. Art effects can also be used.
 <b>Soft Focus</b>	
 <b>Pale&amp;Light Color</b>	
 <b>Light Tone</b>	
 <b>Grainy Film</b>	
 <b>Pin Hole</b>	
 <b>Diorama</b>	
 <b>Cross Process</b>	
 <b>Gentle Sepia</b>	
 <b>Dramatic Tone</b>	
 <b>Key Line</b>	
 <b>Watercolor</b>	
 <b>Vintage</b>	
 <b>Partial Color</b>	
 <b>Bleach Bypass</b>	
 <b>Instant Film</b>	

- Art filters apply only to the JPEG copy. [RAW+JPEG] is automatically selected for image quality in place of [RAW].
- Depending on the scene, the effects of some settings may not be visible, while in other cases tone transitions may be ragged or the image rendered more "grainy".



- You can hide or reveal picture modes using [Picture Mode Settings] (P. 166) in the custom menus.

**1** Press the **OK** button to display the LV super control panel.

**2** Use **Δ ▽ ◀ ▶** to select [Picture Mode].

**3** Use the front dial to select an option.

- Depending on the option selected, picture mode parameters may be displayed in LV super control panel. Adjust parameters as desired (P. 101–104).

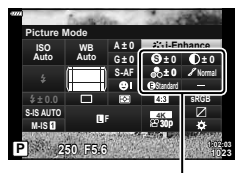
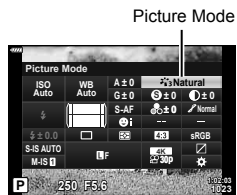

Changes depending on mode selected

## Adjusting overall color

## (Color Creator)

The overall color of the image can be adjusted using any combination of 30 hues and 8 saturation levels.

- 1 Press the **OK** button to display the LV super control panel.
- 2 Use **Δ ∇ ◀ ▶** to select [Picture Mode].
- 3 Rotate the front dial to highlight [Color Creator].
  - A **Color/Vivid** item will appear in the LV super control panel.
- 4 Highlight [**Color/Vivid**] using **Δ ∇** and press the **OK** button.
- 5 Adjust saturation and hue.
  - Rotate the front dial to adjust hue.
  - Rotate the rear dial to adjust saturation.
  - To restore default values, press and hold the **OK** button.

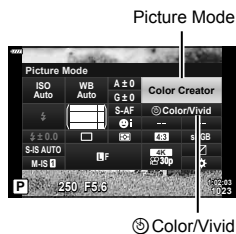

- 6 Press the **OK** button to save changes.
    - You can also save changes by pressing the shutter button halfway.
- Photos are recorded in RAW+JPEG format when [RAW] is selected for image quality (P. 88, 129).
  - Pictures taken using [HDR] (P. 137) or [Multiple Exposure] (P. 139) are recorded at the [Natural] setting.
  - [Color Creator] can be assigned to a camera control. It can be accessed via the button to which [Multi Function] is assigned (P. 113).

## Making fine adjustments to sharpness (Sharpness)

Adjust image sharpness. Outlines can be emphasized for a sharp, clear picture. Settings are stored separately for each picture mode.

- 1 Press the **OK** button to display the LV super control panel.
- 2 Use **Δ ▽ ◀ ▶** to select [Sharpness].
- 3 Use the front dial to select an option.

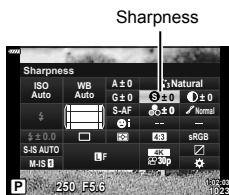

## Making fine adjustments to contrast (Contrast)

Adjust image contrast. Increasing contrast heightens the difference between bright and dark areas for a harder, more well-defined picture. Settings are stored separately for each picture mode.

- 1 Press the **OK** button to display the LV super control panel.
- 2 Use **Δ ▽ ◀ ▶** to select [Contrast].
- 3 Use the front dial to select an option.

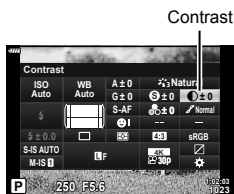

## Making fine adjustments to saturation (Saturation)

Adjust color saturation. Increasing saturation makes pictures more vivid. Settings are stored separately for each picture mode.

- 1 Press the **OK** button to display the LV super control panel.
- 2 Use **Δ ▽ ◀ ▶** to select [Saturation].
- 3 Use the front dial to select an option.

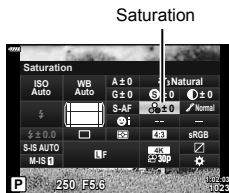

## Making fine adjustments to tone (Gradation)

Adjust color brightness and shading. Bring pictures closer to what you envisage by, for example, brightening the entire picture. Settings are stored separately for each picture mode.

- 1 Press the **OK** button to display the LV super control panel.
- 2 Use **Δ ▽ ◀ ▶** to select [Gradation].
- 3 Use the front dial to select an option.

Gradation

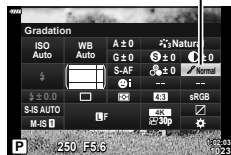

<b>Auto</b> <b>(Shadow Adj)</b>	Divides the image into detailed regions and adjusts the brightness separately for each region. This is effective for images with areas of large contrast in which the whites appear too bright or the blacks appear too dark.
<b>Normal</b> <b>(Gradation Normal)</b>	Optimal shading. Recommended in most circumstances.
<b>High</b> <b>(Gradation High Key)</b>	Uses a tone suitable for a bright subject.
<b>Low</b> <b>(Gradation Low Key)</b>	Uses a tone suitable for a dark subject.

## Applying filter effects to monochrome pictures (Color Filter)

Color filter effects can be added when [Monochrome] is selected for picture mode (P. 98). Depending on the color of the subject, color filter effects can make subjects brighter or enhance contrast. Orange adds more contrast than yellow, red more contrast than orange. Green is a good choice for portraits and the like.

- 1 Press the **OK** button to display the LV super control panel.
- 2 Use **Δ ▽ <|>** to select [Picture Mode].
- 3 Select [Monochrome] using the front dial.
- 4 Use **Δ ▽ <|>** to select [Color Filter].

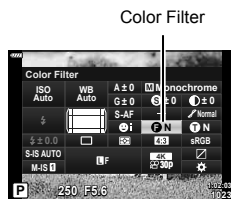

- 5 Select an item using the front dial.

<b>N:None</b>	No filter effect.
<b>Ye:Yellow</b>	Reproduces clearly defined white cloud with natural blue sky.
<b>Or:Orange</b>	Slightly brings out blue skies or the light of the setting sun.
<b>R:Red</b>	Further brings out blue skies or autumn foliage.
<b>G:Green</b>	Adds warmth to skin tones in portraits. The green filter also emphasizes the reds in lipstick.

## Adjusting the tone of a monochrome image (Monochrome Color)

Add a tint to black-and-white pictures in the [Monochrome] picture mode (P. 98).

- 1 Press the  $\odot$  button to display the LV super control panel.
- 2 Use  $\Delta \nabla \triangleleft \triangleright$  to select [Picture Mode].
- 3 Select [Monochrome] using the front dial.
- 4 Use  $\Delta \nabla \triangleleft \triangleright$  to select [Monochrome Color].

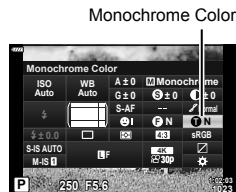

- 5 Use the front dial to select an option.

<b>N:Normal</b>	Creates a normal black and white image.
<b>S:Sepia</b>	Shoot in sepia-tinted monochrome.
<b>B:Blue</b>	Shoot in blue-tinted monochrome.
<b>P:Purple</b>	Shoot in purple-tinted monochrome.
<b>G:Green</b>	Shoot in green-tinted monochrome.

## Adjusting i-Enhance effects (Effect)

Choose the strength of the i-Enhance effect when [i-Enhance] is selected for picture mode (P. 98).

- 1 Press the  $\odot$  button to display the LV super control panel.
- 2 Use  $\Delta \nabla \triangleleft \triangleright$  to select [Effect].
- 3 Use the front dial to select an option.

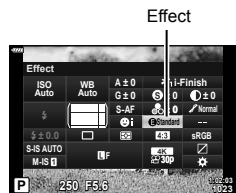

<b>Low (Effect: Low)</b>	Adds a low i-Enhance effect to images.
<b>Standard (Effect: Standard)</b>	Adds an i-Enhance effect between "low" and "high" to images.
<b>High (Effect: High)</b>	Adds a high i-Enhance effect to images.



## Setting the color reproduction format (Color Space)

You can select a format to ensure that colors are correctly reproduced when shot images are regenerated on a monitor or using a printer. This option is equivalent to the [Color Space] (P. 171) in Custom Menu.

- 1 Press the **OK** button to display the LV super control panel.
- 2 Use **Δ ▽ < >** to select [Color Space].
- 3 Use the front dial to select an option.



Color Space

<b>sRGB</b>	The established color space standard for Windows systems. It is widely supported across displays, printers, digital cameras, and computer applications. This setting is recommended in most circumstances.
<b>AdobeRGB</b>	A color space standard defined by Adobe Systems Inc. It can reproduce a wider gamut of colors than sRGB. Accurate color reproduction is available only with software and devices (displays, printers, and the like) that support this standard. An underscore (“_”) appears at the beginning of the file name (e.g., “_xxx0000.jpg”).

- [AdobeRGB] is not available in **AUTO** (Auto, P. 49), **SCN** (P. 50), **ART** (P. 55), HDR, or movie (Movie) mode.

## Changing the brightness of highlights and shadows (Highlight&Shadow Control)

Adjust brightness separately for highlights, mid-tones, and shadows. You gain greater control over exposure than you would with exposure compensation alone. You can selectively make highlights darker or shadows brighter.

- 1 Press the **OK** button to display the LV super control panel.

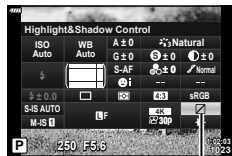

Highlight&Shadow Control

- 2 Use  $\Delta$   $\nabla$   $\triangleleft$   $\triangleright$  to select [Highlight&Shadow Control], then press the **OK** button.
- 3 Press the **INFO** button to choose the desired tone range.
  - The tone range changes each time the button is pressed.



Selected tone range

- 4 Rotate the dials to choose the desired setting.
  - **[Hi. & Sh.] selected**  
Adjust highlights using the front dial and shadows using the rear dial.
  - **[Midtone] selected**  
Use the front or rear dial.
  - Press and hold the **OK** button to restore the default curve.
- 5 Press the **OK** button to save changes.
  - You can also save changes by pressing the shutter button halfway.



## Assigning functions to buttons (Button Function)

Other roles can be assigned to buttons in place of their existing functions.

The functions assigned using [📷 Button Function] take effect only during still photography. The functions assigned using [🎞️ Button Function] take effect in 🎞️ (movie) mode (P. 145).

### ■ Customizable Controls

Button	Default
ISO Button Function	ISO
📷 Button Function	📷 (Exposure compensation)
🔴 Function	🔴 REC
AE-L/AF-ON Function	AEL/AFL
📷/🎞️ Button Function	📷/🎞️ (Still picture), Off (Movie)
O  Function	O

Button	Default
🔍 Function	🔍 (Still picture), 🔍 (Movie)
↔️ Function *1*2	AF Area Select (Still picture), Direct Function (Movie)
▶️ Function *3	⚡ (Still picture), Electronic Zoom *5 (Movie)
▼ Function *3	📷/🎞️ (Still picture), WB (Movie)
LFn Function *4	AF Stop

\*1 The [Direct Function] option for ↔️ button applies to each of Δ ▽ ◀ ▶.

\*2 Assign [::] to the ↔️ button to use it for AF target selection.

\*3 To use [▶️ Function] and [▼ Function] options, you will first have to select [Direct Function] for [↔️ Function].

\*4 The LFn button can be used for the functions available on some lenses.

\*5 Only available with power zoom lenses.





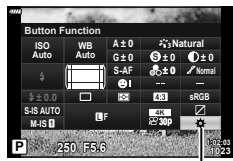





















To change the function assigned to a button, follow the steps below.

- Press the OK button to display the LV super control panel.
- Use Δ ▽ ◀ ▶ to select [Button Function], then press the OK button.
  - [📷 Button Function] of Custom Menu (P. 164) is displayed in still image shooting mode, and [🎞️ Button Function] of [📷 Button/Dial/Lever] (P. 145) is displayed in movie mode.
- Highlight the desired control using Δ ▽ on the arrow pad and press the ▶️ button.
- Highlight a function using the Δ ▽ buttons and press the OK button to assign it to the selected control.
  - The options available vary from button to button.









Button Function









## ■ Available Roles



















Role	Function
<b>AF Stop</b>	Suspend autofocus. Focus locks and autofocus is suspended while the control is pressed. Applies only to lens <b>L-Fn</b> buttons.
<b>AEL/AFL</b> (  )	Lock focus and/or exposure. When used for exposure lock, the control locks exposure when pressed and releases the lock when pressed a second time. The behavior of the control can be selected using  AEL/AFL] in  Custom Menu <b>A1</b> (P. 175).
 <b>REC</b> (movie recording)	The control functions as a movie-record button. Press to start or stop recording.
<b>Direct Function</b> (  /[::]/>/</>)	Assign roles to the buttons on the arrow pad (  ). The following roles can be assigned:  button:  (AF-target selection)  button:  (exposure compensation)  button:  (flash)  button:  (drive mode) <ul style="list-style-type: none"> <li>Use  Function] and  Function] to assign roles respectively to the  and  buttons.</li> </ul>
<b>Preview</b> (  )	Stop aperture down to the selected value. This lets you preview depth of field. Aperture stops down to the currently-selected value while the button is pressed. Preview options can be selected using  Settings] in  Custom Menu <b>D2</b> (P. 167). <ul style="list-style-type: none"> <li>This role is available for  Button Function] only.</li> </ul>
 (one-touch white balance)	Measure a value for one-touch white balance (P. 84). Frame a reference object (a piece of white paper or the like) in the display, then press and hold the control and press the shutter button. A list of one-touch white balance options will be displayed, from which you can choose the location to which the new value will be saved. <ul style="list-style-type: none"> <li>This role is available for  Button Function] only.</li> </ul>
<b>AF Area Select</b> ([::])	Adjust AF-target settings. You can choose the AF-target mode (P. 65) and position (P. 66) and adjust settings for face/eye priority AF (P. 67). Press the control to view the AF-target selection display. Use the front or rear dial to choose AF-target mode and face/eye priority AF settings and the arrow pad to position the AF target.
<b>[::] Home</b> (AF home position) ([::]  )	Recall previously-saved [AF Mode], [AF Target Mode], and [AF Target Point] "home position" settings. Press the control to recall saved settings and press it again to restore the settings previously in effect. Home position settings are saved using [[::] Set Home] in  Custom Menu <b>A2</b> (P. 179). <ul style="list-style-type: none"> <li>This role is available for  Button Function] only.</li> </ul>



Role	Function
<b>MF</b> (AF/MF toggle)	Switch between AF and MF. Press once to select MF and again to return to the previous mode. The focus mode can also be selected by holding the button and rotating a dial. This option has no effect when [mode2] is selected for [Fn Lever Function].
<b>RAW</b> (RAW quality)	Switch between RAW + JPEG and JPEG [] settings. Press the control to switch from RAW or JPEG to RAW + JPEG or from RAW + JPEG to JPEG. You can also choose an image quality setting by holding the button and rotating a dial. • This role is available for [Button Function] only.
<b>Test Picture</b> (TEST)	Take a test shot. You can view the effects of selected settings in an actual photograph. If you keep the control pressed while pressing the shutter button, you will be able to view the results but the picture will not be saved to the memory card. • This role is available for [Button Function] only.
/ (Underwater wide/ Underwater macro)	Press the button to switch between  and . Press and hold the button to return to the original shooting mode. When using a lens with an electronic zoom, switching between  and  is automatically set to the wide-angle setting and the telephoto setting. • This role is available for [Button Function] only.
<b>Exposure</b> (	Adjust exposure settings. Hold the control and rotate the front or rear dial. Alternatively, you can press the button to activate settings and then rotate the dials. The adjustments available vary with the shooting mode: [P]: Use the front or rear dial or  on the arrow pad for exposure compensation. Use the  buttons for program shift. [A]: Use the front or rear dial or  on the arrow pad for exposure compensation. Use the  buttons for aperture. [S]: Use the front or rear dial or  on the arrow pad for exposure compensation. Use the  buttons for shutter speed. [M]: Use the rear dial or  on the arrow pad for shutter speed. Use the front dial or the  buttons for aperture. [B]: Use rear dial or  on the arrow pad to switch between bulb/time and live composite photography. Use the front dial or  buttons to choose the aperture.
<b>Digital Tele-converter</b> ()	Turn the digital teleconverter on or off (P. 130). Press once to zoom in and again to zoom out.
<b>Keystone Comp.</b> ()	Press the control to view keystone compensation settings (P. 141). After adjusting settings, press the control again to exit. To cancel keystone compensation, press and hold the control. • This role is available for [Button Function] only.

Role	Function
<b>Fisheye Compensation</b> (  )	Enable fisheye correction (P. 198). Press once to enable fisheye correction. Press again to disable. Hold the button and rotate the front or rear dial to choose from [Angle] options 1, 2, and 3. • This role is available for [  Button Function] only.
<b>Magnify (Q)</b>	Press the control once to display the zoom frame and again to zoom in (P. 68). Press the control a third time to exit zoom; to hide the zoom frame, press and hold the control. Use the touch controls or the arrow pad (  ) to position the zoom frame.
<b>HDR</b>	Enable HDR (P. 137). Press once to enable HDR. Press again to disable. Hold the button and rotate the front or rear dial to adjust HDR settings, including HDR bracketing. • This role is available for [  Button Function] only.
<b>BKT</b>	Enable bracketing (P. 132). Press once to enable bracketing. Press again to disable. Hold the button and rotate the front or rear dial to adjust [Bracketing] settings. • This role is available for [  Button Function] only.
<b>ISO</b>	Adjust [ISO] settings (P. 70). Hold the control and rotate the front or rear dial. Alternatively, you can press the button to activate settings and then rotate the dials. Use the front or rear dial or  on the arrow pad to adjust settings.
<b>WB (white balance)</b>	Adjust [WB] settings (P. 83). Hold the control and rotate the front or rear dial. Alternatively, you can press the button to activate settings and then rotate the dials. Use the front or rear dial or  on the arrow pad to adjust settings.
<b>Multi Function*</b>	Configure the control for use as a multi-function button (P. 113). Hold the control and rotate the front or rear dial to choose the function performed. The selected function can be performed by pressing the control.
<b>Peaking</b>	Toggle focus peaking on or off (P. 180). Press the control once to turn peaking on and again to turn it off. When peaking is on, peaking options (color, amount) can be displayed by pressing the <b>INFO</b> button.

\* The multi-function button can be assigned the following roles:

 (Highlight&Shadow Control),  (Color Creator),  (ISO),  (WB),  (Magnify),  (Image Aspect),  (S-OVF),  (Peaking)

Role	Function
 <b>Level Disp</b>	Display the digital level gauge. The exposure bar display in the viewfinder functions as a level gauge. Press the control again to exit. This option takes effect when [Style 1] or [Style 2] is selected for [EVF Style] (P. 197) in  Custom Menu  .
 <b>View Selection</b> (display selection)	Switch between viewfinder photography and live view. If [Off] is selected for [EVF Auto Switch] (P. 173), the display will switch between the viewfinder and the monitor. Press and hold the control to display [EVF Auto Switch] options.
<b>S-OVF</b> 	Enable [S-OVF] (P. 173). Press once to turn OVF simulation on. Press again to turn it off. • This role is available for  Button Function] only.
<b>AF Limiter</b>	Enable the AF limiter (P. 163). Press once to enable [AF Limiter]. Press again to disable. Hold the button and rotate the front or rear dial to choose from three stored settings. • This role is available for  Button Function] only.
<b>Preset MF (PreMF)</b>	Toggle [  AF Mode] > [Preset MF] on or off (P. 80). Press the control once to enable preset MF and again to restore the previous focus mode. Alternatively, you can choose the [  AF Mode] by holding the control and rotating a dial. Focus-mode selection using custom controls is not available when [mode2] is chosen for [  Fn Lever Function] (P. 164).
<b>Lens Info Settings</b> (  )	Recall previously-saved lens data (P. 196). Recall saved data for the current lens after changing lenses or the like.
<b>IS Mode</b>	Toggle [Image Stabilizer] on or off (P. 86). Press once to select [Off] and again to turn image stabilization on. Hold the control and rotate the front or rear dial to access [Image Stabilizer] options.
<b>Flicker Scan</b> (  )	Adjust settings for [Flicker Scan] (P. 148, 194). Press the control to select [On]. You can adjust shutter speed for best results while viewing banding in the display. Press the control again to display shooting information and access other settings. Press and hold the control to select [Off] for [Flicker Scann].
<b>Flash Mode</b> 	Adjust flash settings (P. 95). Press once to display flash options and again select the highlighted option and exit. Highlight settings using the front or rear dial or  on the arrow pad. • This function can be assigned to the  and  buttons only. You must first set [  Function] to [Direct Function]. • This role is available for  Button Function] only.

Role	Function
 (sequential shooting/self-timer)	Choose a drive (sequential shooting/self-timer) mode (P. 71). Press the button to display drive mode options and then choose a mode using the front or rear dial or the <math>\triangleleft>\triangleright</math> buttons on the arrow pad. <ul style="list-style-type: none"> <li>This role is available for [📷 Button Function] only.</li> </ul>
 <b>Lock</b> (touch control lock)	Lock touch controls. Press and hold the button once to lock touch controls and again to unlock. <ul style="list-style-type: none"> <li>This function can be assigned to the <math>\triangleright</math> and <math>\triangleleft</math> buttons only. You must first set [🔑 Function] to [Direct Function].</li> </ul>
<b>Electronic Zoom</b>	Zoom power zoom lenses in or out. After pressing the control, use the arrow pad to zoom in or out. Use $\triangleup$ or $\triangleright$ on the arrow pad to zoom in and $\nabla$ or $\triangleleft$ to zoom out. <ul style="list-style-type: none"> <li>This function can be assigned to the <math>\triangleright</math> and <math>\triangleleft</math> buttons only. You must first set [🔑 Function] to [Direct Function].</li> </ul>
<b>Movie</b> 	Zoom in or out using the movie teleconverter (P. 59). Press the control once to display the zoom frame and again to zoom in. Press the control a third time to exit zoom; to hide the zoom frame, press and hold the control. Use touch controls or the arrow pad ( $\triangleup$ $\nabla$ $\triangleleft$ $\triangleright$ ) to position the zoom frame. <ul style="list-style-type: none"> <li>This role is available for [📷 Button Function] only.</li> </ul>
<b>S-AF</b>	Focus using [S-AF]. Press the control to focus. Focus will lock while the control is pressed. <ul style="list-style-type: none"> <li>This role is available for [📷 Button Function] only.</li> </ul>
<b>Off</b>	The control is not used.



## ■ Using multi function options (Multi Function)

Assign multiple roles to a single button.

- To use the multi function feature, you must first assign [Multi Function] to a camera control (P. 107).

### Choosing a function

- Hold the button to which [Multi Function] is assigned and rotate the front or rear dial.
  - Rotate the dial until the desired feature is highlighted. Release the button to select the highlighted feature.



- Press the button to which [Multi Function] is assigned.
- Adjust settings.

<b>Highlight&amp;Shadow Control</b>	Adjust brightness using the front or rear dial. Press the <b>INFO</b> button to choose the tone range (highlights, shadows, or mid-tones).
<b>Color Creator</b>	Use the front dial to adjust hue and the rear dial to adjust saturation.
<b>ISO</b>	Choose a setting using the front or rear dial.
<b>WB</b>	
<b>Magnify</b>	The zoom frame will be displayed.
<b>Image Aspect</b>	Choose a setting using the front or rear dial.
<b>S-OVF</b>	Press the button to turn the feature on or off.
<b>Peaking</b>	

- You can choose the options displayed. [Multi Function Settings] (P. 166)

# 3 Playback

## Information display during playback

### Playback image information

#### Simplified display

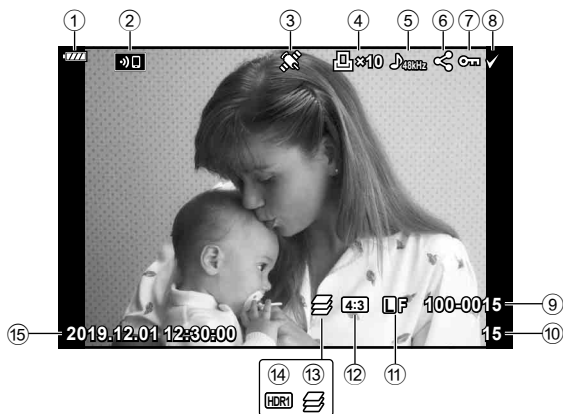

#### Overall display

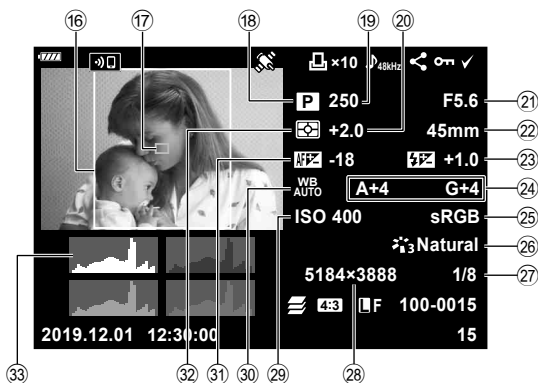

- |  |  |
|--|--|
| ① Battery level.....P. 26                    | ⑪ AF area pointer.....P. 65            |
| ② Wireless LAN connection.....P. 200–207     | ⑫ Shooting mode.....P. 34–59           |
| ③ Including GPS information.....P. 205       | ⑬ Shutter speed.....P. 37–43           |
| ④ Print order<br>Number of prints.....P. 120 | ⑭ Exposure compensation.....P. 64      |
| ⑤ Sound record.....P. 122                    | ⑮ Aperture value.....P. 37–43          |
| ⑥ Share order.....P. 119                     | ⑯ Focal length                         |
| ⑦ Protect.....P. 118                         | ⑰ Flash intensity control.....P. 97    |
| ⑧ Image selected.....P. 119                  | ⑱ White balance compensation.....P. 85 |
| ⑨ File number.....P. 172                     | ⑲ Color space.....P. 105               |
| ⑩ Frame number                               | ⑳ Picture mode.....P. 98, 129          |
| ⑪ Image quality.....P. 88, 129               | ㉑ Compression rate.....P. 196          |
| ⑫ Aspect ratio.....P. 87                     | ㉒ Pixel count.....P. 196               |
| ⑬ Focus stacking.....P. 134                  | ㉓ ISO sensitivity.....P. 70, 80        |
| ⑭ HDR image.....P. 137                       | ㉔ White balance.....P. 83              |
| ⑮ Date and time.....P. 27                    | ㉕ Focus adjustment.....P. 163          |
| ⑯ Aspect border.....P. 87                    | ㉖ Metering mode.....P. 82              |
|  | ㉗ Histogram                            |

## Switching the information display

You can switch the information displayed during playback by pressing the **INFO** button.

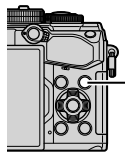

**INFO** button

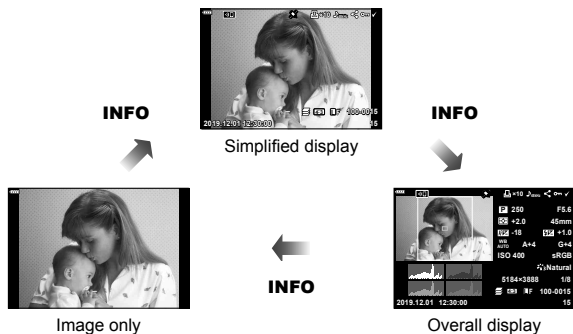









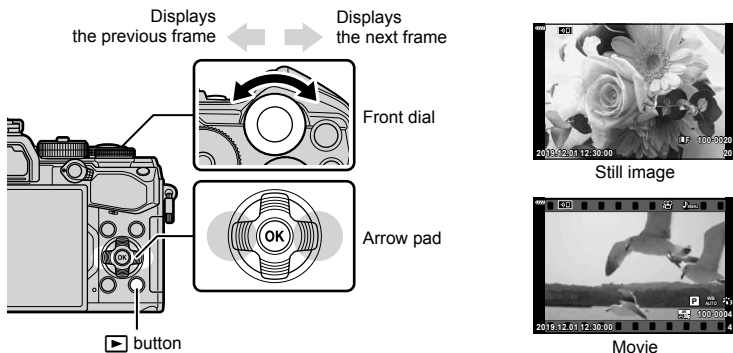











- You can add histogram, highlight & shadow, and Light Box to the information displayed during playback. [Info] (P. 188)

## Viewing photographs and movies



### 1 Press the button.

- Your most recent photograph or movie will be displayed.
- Select the desired photograph or movie using the front dial () or arrow pad.
- Press the shutter button halfway to return to shooting mode.



<b>Rear dial</b> (  )	Zoom in (  ) / Index (  )
<b>Front dial</b> (  )	Previous (  ) / Next (  ) Operation also available during close-up playback.
<b>Arrow pad</b> (  )	Single-frame playback: Next (  ) / previous (  ) / playback volume (  ) Close-up playback: Changing the close-up position You can display the next frame (  ) or the previous frame (  ) during close-up playback by pressing the <b>INFO</b> button. Press the <b>INFO</b> button again to display a zoom frame and use    to change its position. Index/calendar playback: Highlight image
<b>INFO button</b>	View image info
<b> () button</b>	Select picture (P. 119)
<b> (<b>AEL/AFL</b>) button</b>	Protect picture (P. 118)
<b> button</b>	Delete picture (P. 119)
<b> button</b>	View menus (in calendar playback, press this button to exit to single-frame playback)

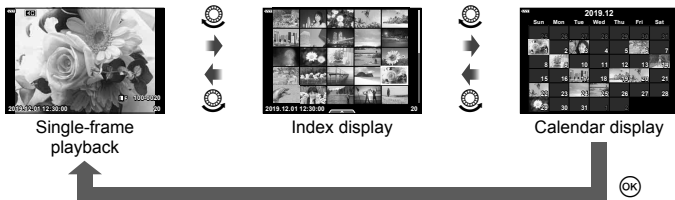

## Finding Pictures Quickly (Index and Calendar Playback)

- In single-frame playback, rotate the rear dial to  for index playback. Rotate further for calendar playback.
- Turn the rear dial to  to return to single-frame playback.



- You can change the number of frames for index display.  [Settings] (P. 189)



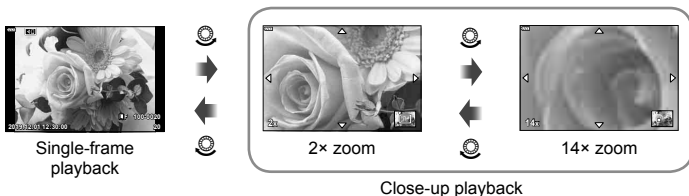

## Zooming In (Playback Zoom)

In single-frame playback, turn the rear dial to  to zoom in. Turn to  to return to single-frame playback.







## Rotating Pictures (Rotate)

Choose whether to rotate photographs.

- 1 Play the photograph back and press the  button.
- 2 Select [Rotate] and press the  button.
- 3 Press  to rotate the image counterclockwise,  to rotate it clockwise; the image rotates each time the button is pressed.
  - Press the  button to save settings and exit.
  - The rotated image is saved in its current orientation.
  - Movies and protected images cannot be rotated.



- The camera can be configured to automatically rotate portrait-orientation pictures during playback.   playback menu >  (P. 153)  
[Rotate] is not available when [Off] is selected for .

## Watching movies

Select a movie and press the **OK** button to display the playback menu. Select [Play Movie] and press the **OK** button to begin playback. Fast-forward and rewind using **</>**. Press the **OK** button again to pause playback. While playback is paused, use **△** to view the first frame and **▽** to view the last frame. Use **</>** or the front dial (**⊙**) to view previous or next frame. Press the **MENU** button to end playback.



### Viewing Movies over 4 GB in Size

Long movies may exceed 4 GB in size. Movies over 4 GB in size are recorded over multiple files. The files can be played back as a single movie.

- 1 Press the **▶** button.
  - The most recent picture will be displayed.
- 2 Display a long movie you want to view and press the **OK** button.
  - The following options will be displayed.
 

[Play from Beginning]:	Plays back a split movie all the way through
[Play Movie]:	Plays back files separately
[Delete entire ]:	Deletes all parts of a split movie
[Erase]:	Deletes files separately

- We recommend using the latest version of Olympus Workspace to play back movies on a computer (P. 209). Before launching the software for the first time, connect the camera to the computer.

## Protecting Pictures

(**⊙**)



Protect images from accidental deletion. Display the image you want to protect and press the **⊙** (**AEL/AFL**) button to add **⊙** to the image (protection icon). Press the **⊙** (**AEL/AFL**) button again to cancel protection. You can also protect multiple selected images. **ⓘ** “Selecting Multiple Pictures (**⊙**, Erase Selected, Share Order Selected)” (P. 119)

- Formatting the card erases all data including protected images.



## Deleting Pictures

(Erase)



Display an image you want to delete and press the  button. Select [Yes] and press the  button.

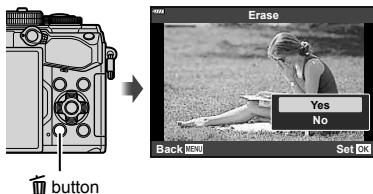

You can erase images without the confirmation step by changing the button settings.  [Quick Erase] (P. 173)



## Selecting Pictures for Sharing









(Share Order)

You can select images you want to transfer to a smartphone in advance. When playing back images you want to transfer, press the  button to display the playback menu. After selecting [Share Order] and pressing the  button, press  $\Delta$  or  $\nabla$  to set a share order on an image and display . To cancel a share order, press  $\Delta$  or  $\nabla$ .

You can select images you want to transfer in advance and set a share order all at once.  "Selecting Multiple Pictures (, Erase Selected, Share Order Selected)" (P. 119), "Transferring images to a smartphone" (P. 203)

- You can set a share order on 200 frames.
- Share orders cannot include RAW images.









Pictures can also be marked for sharing using the  () button. If the  () button is currently assigned a role other than , assign it the  role using the [  Function] option in the custom menus (P. 164).





## Selecting Multiple Pictures

(, Erase Selected, Share Order Selected)

You can select multiple images for , [Erase Selected] or [Share Order Selected].

Press the  () button to select an image; a  icon will appear on the image. Press the  () button again to cancel the selection.

Press the  button to display the menu, and then select from , [Erase Selected] or [Share Order Selected]. This function is also available in single-frame playback.



You can save digital “print orders” to the memory card listing the pictures to be printed and the number of copies of each print. You can then have the pictures printed at a print shop that supports DPOF. A memory card is required when creating a print order.

### ■ Creating a print order

- 1 Press the **OK** button during playback and select **[P]** (Print Order).
- 2 Select **[P]** or **[P]ALL** and press the **OK** button.

#### Individual picture

Press **<D>** to select the frame that you want to set as print reservation, then press **Δ∇** to set the number of prints.

- To set print reservation for several pictures, repeat this step. Press the **OK** button when all the desired pictures have been selected.

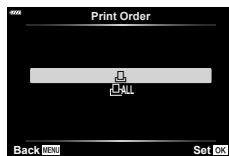

#### All pictures

Select **[P]ALL** and press the **OK** button.

- 3 Select the date and time format and press the **OK** button.

<b>No</b>	The pictures are printed without the date and time.
<b>Date</b>	The pictures are printed with the shooting date.
<b>Time</b>	The pictures are printed with the shooting time.

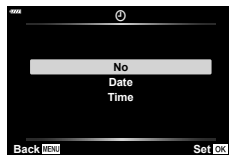











- When printing images, the setting cannot be changed between the images.

- 4 Select **[Set]** and press the **OK** button.
  - The setting will be applied to the images saved on the card being used for playback.
  - The camera cannot be used to modify print orders created with other devices. Creating a new print order deletes any existing print orders created with other devices.
  - Print orders cannot include RAW images or movies.



### ■ Removing all or selected pictures from the print order

You can reset all print reservation data or just the data for selected pictures.

- 1 Press the  button during playback and select [] (Print Order).
- 2 Select [] and press the  button.
  - To remove all pictures from the print order, select [Reset] and press the  button. To exit without removing all pictures, select [Keep] and press the  button.
- 3 Press  to select images you wish to remove from the print order.
  - Use  to set the number of prints to 0. Press the  button once you have removed all the desired pictures from the print order.
- 4 Select the date and time format and press the  button.
  - This setting is applied to all frames with print reservation data.
  - The setting will be applied to the images saved on the card being used for playback.
- 5 Select [Set] and press the  button.

## Adding Audio to Pictures



You can record audio using the built-in stereo microphone or an optional external microphone and add it to pictures. The recorded audio provides a simple replacement for written notes about the pictures.

- Audio recordings can be up to 30 s long.

- 1 Display the image to which you want to add audio and press the **OK** button.
  - Audio recording is not available with protected images.
  - Audio can also be added to pictures using the [Edit] option in the playback menu. Use [Edit] > [Sel. Image] to select the picture, then press the **OK** button and select **[U]**.
- 2 Select **[U]** and press the **OK** button.
  - To exit without adding audio, select [No].

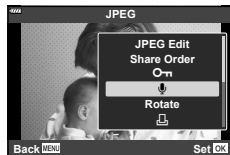

- 3 Select **[U Start]** and press the **OK** button to begin recording.
- 4 Press the **OK** button to end recording.
  - Pictures with audio are indicated by icons and indicators showing the recording rate.
  - To delete recorded audio, select [Erase] in Step 3.



- Audio is recorded at the rate selected for movies. The rate can be selected using [Movie ] (P. 146, 150) in the video menu.

### ■ Audio Playback

Playback begins automatically when a picture with audio is displayed. To adjust the volume:

- 1 Press the **▶** button to display a picture.
- 2 Press **Δ** or **∇** on the arrow pad.
  - **Δ** button: Raise volume.
  - **∇** button: Lower volume.



## Playback Using Touch Controls

Pictures can be viewed using touch controls.



### ■ Full-frame playback

#### Displaying the previous or next image

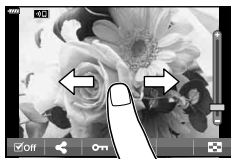
- Slide your finger to the left to view the next image, and right to view the previous image.







### ■ Magnify

- Lightly tap the screen to display the slider and .
- Slide the bar up or down to zoom in or out.
- Slide your finger to scroll the display when the picture is zoomed in.
- Tap  to display index playback.  
Tap  for calendar playback.



### ■ Index/Calendar playback

#### Displaying the previous or next page

- Slide your finger up to view the next page, and down to view the previous page.
- Tap  or  to switch the number of images displayed.  [Settings] (P. 166)
- Tap  several times to return to single-frame playback.

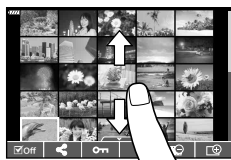





### Viewing images

- Tap an image to view it full frame.

## Selecting and protecting images

In single-frame playback, lightly tap the screen to display the touch menu. You can then perform the desired operation by tapping the icons in the touch menu.

	Select an image. You can select multiple images and delete them collectively.
	Images you want to share with a smartphone can be set.  “Selecting Pictures for Sharing (Share Order)” (P. 119)
	Protects an image.

- Do not tap the display with your fingernails or other sharp objects.
- Gloves or monitor covers may interfere with touch screen operation.

# 4 Menu functions

## Basic menu operations

The menus contain shooting and playback options that are not displayed by the LV super control panel, etc., and let you customize the camera settings for easier use.

Tab	Tab name	Description
	<b>Shooting Menu 1</b>	Photography-related items. Ready the camera for shooting or access basic photo settings.
	<b>Shooting Menu 2</b>	Photography-related items. Adjust advanced photo settings.
	<b>Video Menu</b>	Items related to movie recording. Adjust basic and custom settings.
	<b>Playback Menu</b>	Playback- and retouch-related items.
	<b>Custom Menu</b>	Items for customizing the camera.
	<b>Setup Menu</b>	Items for setting the clock, choosing a language, and the like.

- 1 Press the **MENU** button to display the menus.

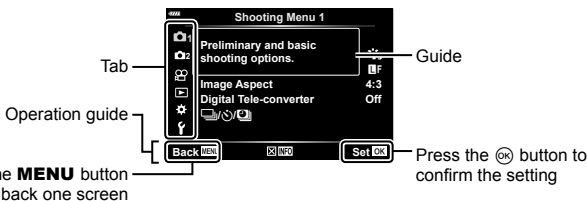

- A guide is displayed about 2 seconds after you select an option. Press the **INFO** button to view or hide guides.

- 2 Use  $\Delta$ / $\nabla$  to select a tab and press the **OK** button.

- The menu group tab appears when the **Custom** Menu is selected. Use  $\Delta$ / $\nabla$  to select the menu group and press the **OK** button.

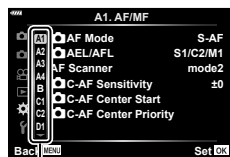

Menu group

- 3 Select an item using  $\Delta$ / $\nabla$  and press the  $\text{OK}$  button to display options for the selected item.

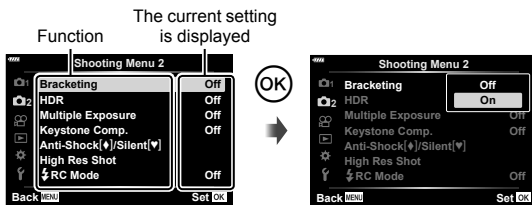

- 4 Use  $\Delta$ / $\nabla$  to highlight an option and press the  $\text{OK}$  button to select.

- Press the **MENU** button repeatedly to exit the menu.
- For the default settings of each option, refer to “Default Settings” (P. 229).
- Depending on camera status and settings, some items may be unavailable. Items that are not available are grayed out and cannot be selected.
- You can also navigate the menus using the front and rear dials in place of the arrow pad.

## Using Shooting Menu 1/Shooting Menu 2



### Shooting Menu 1

- 1 Reset / Custom Modes (P. 127)
- Picture Mode (P. 98, 129)
- (P. 88, 129)
- Image Aspect (P. 87)
- Digital Tele-converter (P. 130)
- (drive/time-lapse shooting) (P. 71, 73, 131)

### Shooting Menu 2

- 2 Bracketing (P. 132)
- HDR (P. 137)
- Multiple Exposure (P. 139)
- Keystone Comp. (P. 141)
- Anti-Shock /Silent (P. 142)
- High Res Shot (P. 143)
- RC Mode (P. 143, 216)







## Restoring Default Settings (Reset)

Camera settings can be easily restored to default settings. You can opt to reset almost all settings or only those directly related to photography.

- 1 Select [Reset / Custom Modes] in Shooting Menu 1 and press the button.
  - 2 Select [Reset] and press the button.
- 
- 3 Highlight [Full] or [Basic], and press the button.
    - To reset all settings except the time, date, and a few others, highlight [Full] and press the button. "Default Settings" (P. 229)
  - 4 Press the button in the [Reset / Custom Modes] menu.
  - 5 Select [Yes] and press the button.





**Editing custom settings**

Current camera settings can be saved to any of three Custom Modes. Saved settings can be recalled by rotating the mode dial to **C** or using [Recall from Custom Mode].

- [Custom Mode C2] and [Custom Mode C3] can be recalled using [Recall from Custom Mode].
- 1 Adjust settings in order to save.
    - Set the mode dial to the positions other than **AUTO** (📷), **ART**, or movie (🎥) mode.
  - 2 Select [Reset / Custom Modes] in  Shooting Menu 1 and press the  button.
  - 3 Select [Assign to Custom Mode] and press .
  - 4 Highlight the desired destination ([Custom Mode C], [Custom Mode C2], or [Custom Mode C3]) and press the  button.
  - 5 Select [Set] and press the  button.
    - Any existing settings will be overwritten.
    - To restore default settings for the selected custom mode, highlight [Reset] and press the  button.

**Recalling Saved Settings**

In modes **P**, **A**, **S**, **M**, **B**, and **C**, you can recall saved settings but not the shooting mode. The shooting mode remains that currently selected with the mode dial.



- 1 Select [Reset / Custom Modes] in  Shooting Menu 1 and press the  button.
- 2 Select [Recall from Custom Mode] and press .
- 3 Highlight [Custom Mode C], [Custom Mode C2], or [Custom Mode C3] and press .
- 4 Select [Yes] and press the  button.
  - Settings saved to [Custom Mode C] can be recalled by rotating the mode dial to **C**.



## Processing options

(Picture Mode)

You can make individual adjustments to contrast, sharpness and other parameters in [Picture Mode] (P. 98) settings. Changes to parameters are stored for each picture mode separately.

- 1 Select [Picture Mode] in  Shooting Menu 1 and press the  button.
  - The camera will display the picture mode available in the current shooting mode.



- 2 Select an option with   and press the  button.









- Press  to set the detailed options for the selected picture mode. Detailed options are not available for some picture modes.
- Changes to contrast have no effect at settings other than [Normal].







- You can reduce the number of picture mode options displayed in the menu.  
 [Picture Mode Settings] (P. 166)

## Photo File and Image Size Options





-  "Photo File and Image Size Options (  )" (P. 88)
- You can change the JPEG image size and compression ratio combination, and [] and [] pixel counts. [ Set], [Pixel Count]  "Combinations of JPEG image sizes and compression rates ( Set)" (P. 196)

This option takes a crop at the center of the frame the same dimensions as the size option currently selected for image quality and zooms it in to fill the display. The zoom ratio increases by about 2×. This allows you to zoom in past the lens' maximum focal length, making it a good choice when you are unable to switch lenses or find it difficult to get any closer to your subject.

- 1 Select [Digital Tele-converter] in  Shooting Menu 1, and press the  button.
- 2 Highlight [On], and press the  button.
- 3 Press the **MENU** button to exit the menus.
  - When [On] is selected, the zoom ratio increases by 2× and a  icon is displayed. Pictures will be recorded at the new zoom ratio.

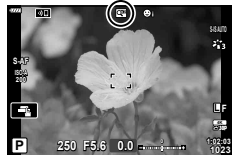

Digital teleconverter





- The digital teleconverter cannot be used with multiple exposure, keystone compensation, fisheye correction, or the **SCN** mode panorama option.
- This function is not available when the information of [Movie Effect] is displayed on the screen in movie mode.
- This function is not available when [Movie ] is assigned to a button with  Button Function].
- JPEG images are recorded at the selected zoom ratio. In the case of RAW images, a frame shows the zoom crop. A frame showing the zoom crop is displayed on the image during playback.
- During zoom, the size of the AF targets increases and their number decreases.

## Shooting automatically with a fixed interval (Time lapse shooting)

You can set the camera to shoot automatically with a set time lapse. The shot frames can also be recorded as into a single movie. This setting is only available in **P/A/S/M** modes.

- 1 Select  in  Shooting Menu 1 and press the  button.



- 2 Select [Intrvl. Sh./Time Lapse] and press .
- 3 Select [On] and press .
- 4 Adjust the following settings and press the  button.

<b>Number of Frames</b>	Sets the number of frames to be shot.
<b>Start Waiting Time</b>	Choose how long the camera waits before starting interval timer photography and taking the first shot.
<b>Interval Length</b>	Choose how long the camera waits between shots once shooting has begun.
<b>Time Lapse Movie</b>	Choose whether to record a time-lapse movie. [Off]: The camera saves the individual shots but does not use them to create a time-lapse movie. [On]: The camera records the individual shots and also uses them to create a time-lapse movie.
<b>Movie Settings</b>	Choose the frame size ([Movie Resolution]) and frame rate ([Frame Rate]) for movies created using [Time Lapse Movie].

- 5 Press the  button repeatedly to return to  Shooting Menu 1.

- Press the **MENU** button to exit the menus.
- A  icon will appear in the shooting display (the icon shows the selected number of shots).

Interval-timer photography



- 6 Take pictures.

- Frames are shot even if the image is not in focus after AF. If you wish to fix the focus position, shoot in MF.
- [Rec View] (P. 159) operates for 0.5 seconds.

- If either of the time before shooting, or shooting interval is set to 1 minute 31 seconds or longer, the monitor and camera power will turn off after 1 minute. 10 seconds before shooting, the power will automatically turn on again. When the monitor is off, press the shutter button to turn it on again.
- If the AF mode (P. 80) is set to [C-AF] or [C-AF+TR], it is automatically changed to [S-AF].
- Touch operations are disabled during time lapse shooting.
- This function cannot be used with HDR photography.
- Time-lapse shooting cannot be combined with bracketing or multiple exposure.
- The flash will not work if the flash charging time is longer than the interval between shots.
- If the camera automatically turns off in interval between shots, it will turn on in time for the next shot.
- If any of still pictures are not recorded correctly, the time lapse movie will not be generated.
- If there is insufficient space on the card, the time lapse movie will not be recorded.
- Time lapse shooting will be canceled if any of the following is operated:  
Mode dial, **MENU** button,  button, lens release button, or connecting the USB cable.
- If you turn off the camera, time lapse shooting will be canceled.
- If there is not enough charge left on the battery, the shooting may end partway through. Make sure the battery is charged enough before shooting.
- Time-lapse movies created at a size of [4K] may not display on some computer systems. More information is available on the OLYMPUS website.

## Varying settings over a series of photographs (Bracketing)

Bracketing is used to vary shooting settings such as exposure and white balance over a series of shots. Depending on the setting, you may be able to combine several different forms of bracketing. Use bracketing if you are unsure what settings to use or lack the time needed to change settings during shooting. You can also store bracketing settings and later recall them simply by turning bracketing on.

### AE BKT (AE bracketing)

The camera varies the exposure of each shot. You can select the bracketing increment from 0.3 EV, 0.7 EV, and 1.0 EV. In single-frame shooting mode, one photograph is taken each time the shutter button is pressed all the way down, while in sequential shooting mode the camera continues to take shots in the following order while the shutter button is pressed all the way down: no modification, negative, positive. Number of shots: 2, 3, 5, or 7

- The camera modifies exposure by varying aperture and shutter speed (**P** mode), shutter speed (**A** and **M** modes), or aperture (**S** mode). If [All] is selected for [ISO-Auto] (P. 169) in **M** mode and [AUTO] is selected for [ISO] (P. 70, 80), the camera modifies exposure by varying ISO sensitivity.
- The camera brackets the value currently selected for exposure compensation.
- The size of the bracketing increment changes with the value selected for [EV Step].  [EV Step] (P. 169)
- Exposure bracketing cannot be combined with FL or focus bracketing.

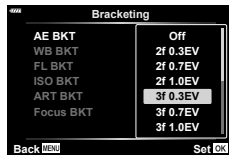

### **WB BKT (WB bracketing)**

Three images with different white balances (adjusted in specified color directions) are automatically created from one shot, starting with the value currently selected for white balance.

- White balance can be varied by 2, 4, or 6 steps on each of the A–B (Red–Blue) and G–M (Green–Magenta) axes.
- The camera brackets the value currently selected for white balance compensation.
- WB bracketing cannot be combined with ART or focus bracketing.



### **FL BKT (FL bracketing)**

The camera varies flash level over three shots (no modification on the first shot, negative on the second, and positive on the third). The amount can be chosen from 0.3, 0.7, and 1.0 EV. In single-frame shooting, one shot is taken each time the shutter button is pressed; in sequential shooting, all shots are taken while the shutter button is pressed.

- The size of the bracketing increment changes with the value selected for [EV Step]. [EV Step] (P. 169)
- Flash bracketing cannot be combined with AE or focus bracketing.

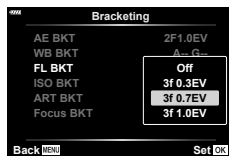

### **ISO BKT (ISO bracketing)**

The camera varies the sensitivity over three shots while keeping the shutter speed and aperture fixed. You can select the bracketing increment from 0.3 EV, 0.7 EV, and 1.0 EV. Each time the shutter button is pressed, the camera shoots three frames with the set sensitivity (or if auto sensitivity is selected, the optimal sensitivity setting) on the first shot, negative modification on the second shot, and positive modification on the third shot.

- The size of the bracketing increment does not change with the value selected for [ISO Step]. [ISO Step] (P. 169)
- Bracketing is performed regardless of the upper limit set with [ISO-Auto Set]. [ISO-Auto Set] (P. 169)
- ISO sensitivity bracketing cannot be combined with ART or focus bracketing.

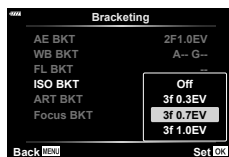

### **ART BKT (ART bracketing)**

Each time the shutter is released, the camera records multiple images, each with a different art filter setting. You can turn art filter bracketing on or off separately for each picture mode.

- Recording may take some time.
- With the exceptions of AE and FL bracketing, ART bracketing cannot be combined with other forms of bracketing.

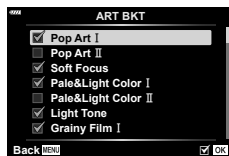

### Focus BKT (Focus bracketing)

Take a series of shots at different focus positions. Focus moves successively farther from the initial focus position. Choose the number of shots using [Set number of shots] and the change in focus distance using [Set focus differential]. Choose smaller values for [Set focus differential] to narrow the change in focus distance, larger values to widen it. If you are using a flash other than the dedicated flash unit, you can specify the time it takes to charge using the [Charge Time] option.

Press the shutter button all the way down and release it immediately. Shooting will continue until the selected number of shots is taken or until the shutter button is pressed all the way down again.

- Focus bracketing is not available with lenses that have mounts conforming to the Four-Thirds standard.
- Focus bracketing ends if zoom or focus is adjusted during shooting.
- Shooting ends when focus reaches infinity.
- Pictures taken using focus bracketing are shot in silent mode.
- To use the flash, select [Allow] for [Silent (♥) Mode Settings] > [Flash Mode].
- [Silent (♥) Mode Settings] (P. 142)
- Focus bracketing cannot be combined with other forms of bracketing.

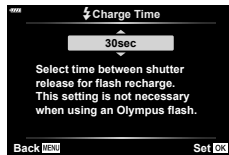
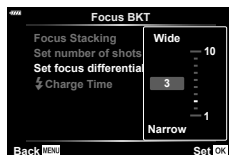
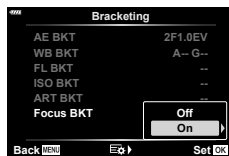

### Focus BKT (Focus Stacking)

The focus position is automatically shifted to capture 8 shots which are then composited for a single JPEG image that is in focus all the way from the foreground to background.

- The focus position is automatically shifted based on the center of the focal position and 8 frames are captured in a single shot.
- If compositing fails, the image will not be saved.
- Focus stacking ends if zoom or focus is adjusted during shooting.
- The angle of view for composited images is narrower than the original images.
- A frame indicating the final crop will be shown in the display. Compose the shot with your subject in the frame.
- Guide line selected in [Displayed Grid] (P. 168) will not be displayed.
- See the OLYMPUS website for information on the lenses that can be used with [Focus Stacking].
- Focus stacking cannot be combined with other forms of bracketing.

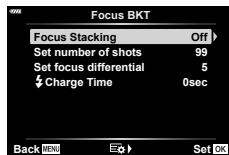

- 1 Select [Bracketing] in **Shooting Menu 2** and press the **OK** button.

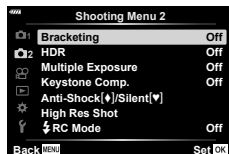

- 2 After selecting [On], press **▶** and select a bracket shooting type.
  - A menu of bracketing types will be displayed.

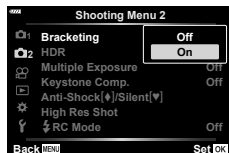

- 3 Highlight a bracketing type using the **▲▼** buttons and press the **▶** button.
  - The camera will display bracketing options for the selected bracketing type.

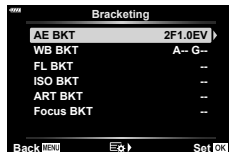

- 4 Using the **▲▼◀▶** buttons, select [On] or a bracketing program.
  - **AE BKT**

Highlight the number of shots (for example, 2f) and press the **▶** button to view bracketing amounts. Use the **▲▼** buttons to highlight an amount and press **OK** to select the highlighted option and return to the previous display.

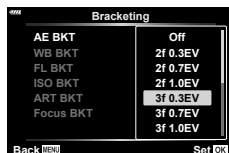

- **WB BKT**

You will be prompted to choose a color axis (A–B or G–M). Use the **◀▶** buttons to highlight an axis and the **▲▼** buttons to choose the bracketing amount. Press the **OK** to return to the previous display when settings are complete.



- **ART BKT**

Highlight [On] and press the **▶** button to display a menu of picture modes and art filters. Use the **▲▼** buttons to highlight the desired filters and press the **OK** button to select (selected filters are indicated by check marks). Press the **MENU** button to return to the previous display when settings are complete.

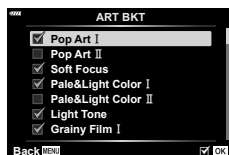

- **Focus BKT**

Highlight [On] and press the  $\triangleright$  button to view focus bracketing settings. Use the  $\Delta$   $\nabla$  buttons to highlight a setting and press the  $\triangleright$  button. Options will be displayed; use the  $\Delta$   $\nabla$  buttons to highlight an option and press the  $\odot$  button to return to the setting menu. Press the  $\odot$  button again to return to the bracketing menu when settings are complete. The [Focus BKT] menu is also used for [Focus Stacking] settings (P. 134).

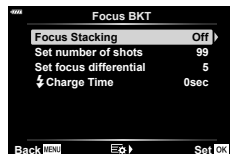

5 With [On] selected, press the  $\odot$  button to save changes and exit.

6 Confirm that [On] is selected for [Bracketing] and press the  $\odot$  button.

- To save changes without enabling bracketing, press the **MENU** button or highlight [Off] and press the  $\odot$  button.

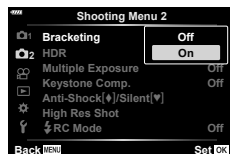

7 Take pictures.



- A **[BKT]** icon is displayed when bracketing is active.
- Bracketing cannot be combined with HDR, interval-timer photography, digital shift, multiple-exposure photography, high res shots, or fisheye compensation.
- Bracketing is not available if there is not enough space on the camera's memory card for the selected number of frames.
- AE, FL, and focus bracketing are not available in mode **B**.







## Taking HDR (High Dynamic Range) images (HDR)

The camera varies exposure over a series of shots, selects from each tone range with the highest level of detail, and combines them to create a single picture with a wide dynamic range. If the photo features a high-contrast subject, details that would otherwise be lost in shadows or highlights will be preserved.

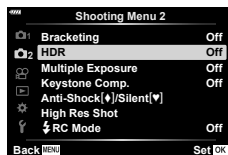
- This option is available in **P**, **A**, **S**, and **M** modes.

- 1 Press the **MENU** button to display the menus.
- 2 Highlight [HDR] in  Shooting Menu 2 and press  on the arrow pad.



- 3 Highlight an option using the   buttons and press the  button.

-  Shooting Menu 2 will be displayed.

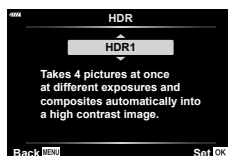

<b>HDR1</b>	Each time you take a photo, the camera will take a series of shots while varying exposure and combine them into a single picture. Choose [HDR1] for natural-looking results, [HDR2] for a more painterly effect. <ul style="list-style-type: none"> <li>• [ISO] is fixed at ISO 200.</li> </ul>
<b>HDR2</b>	<ul style="list-style-type: none"> <li>• Shutter speeds can be as slow as 4 s. Shooting will continue for up to 15 s.</li> <li>• Picture mode is fixed at [Natural] and color space at [sRGB].</li> <li>• The combined picture is saved in JPEG format. If [RAW] is selected for image quality, it will instead be recorded in RAW + JPEG format.</li> </ul>
<b>3f 2.0EV</b>	Each time you take a photo, the camera will vary exposure over a series of shots. The shots are not combined to create a single picture. The shots can however be combined using HDR software on a computer or other device. <div style="text-align: center; margin-top: 20px;"> <p><b>3f 2.0EV</b></p> <p>Number of shots      Exposure range</p> </div>
<b>5f 2.0EV</b>	
<b>3f 3.0EV</b>	
<b>5f 3.0EV</b>	
<b>7f 2.0EV</b>	

#### 4 Press the **MENU** button repeatedly to exit the menus.



- The camera will return to the shooting display. An **[HDR]** icon will be displayed.
- The drive mode will be fixed at  (sequential high).



#### 5 Take pictures.

- Each time you press the shutter button, the camera will take the selected number of shots.
- In [HDR1] and [HDR2] modes, the camera will automatically combine the shots into a single picture.
- Exposure compensation is available in modes **P**, **A**, and **S**.
- In mode **M**, the camera takes the values selected for aperture and shutter speed as a base for HDR photography.
- Use a tripod or take similar measures to fix the camera in place.
- The image displayed in the monitor or viewfinder during shooting differs from the final HDR picture.
- Noise may appear in the final picture when a slower shutter speed is selected in [HDR1] or [HDR2] mode.
- The following cannot be used:  
flash photography, bracketing, multiple exposure, interval-timer photography, keystone compensation, and fisheye correction.



- [HDR] can be assigned to a button. You then need only press the button to enable it.  
 [  Button Function ] (P. 107)

## Recording multiple exposures in a single image (Multiple Exposure)

Take two shots and combine them into a single picture. Alternatively, you can take a shot and combine it with an existing picture stored on the memory card.

The combined image is recorded at current image quality settings. Only RAW pictures can be selected for multiple exposures that include an existing image.

If you record a multiple exposure with RAW selected for [OK], you can then select it for subsequent multiple exposures using [Overlay], allowing you to create multiple exposures combining three or more photographs.

- This option is available in **P**, **A**, **S**, **M**, and **B** modes.

- 1 Select [Multiple Exposure] in **C2** Shooting Menu 2 and press the **OK** button.
- 2 Use  $\Delta$   $\nabla$  to select the item and press **▷**.
  - Use  $\Delta$   $\nabla$  to select the setting and press the **OK** button.

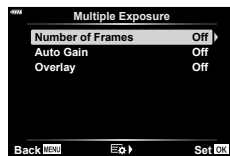

<b>Number of Frames</b>	[Off]: Do not create additional multiple exposures. [2f]: Create a multiple exposure from 2 pictures.
<b>Auto Gain</b>	[On]: Halve the brightness of each picture in the multiple exposure. [Off]: Do not adjust brightness the brightness of the pictures in the multiple exposure.
<b>Overlay</b>	[On]: Shoot a multiple exposure that includes an existing RAW image stored on the memory card. [Off]: Create a multiple exposure from the next 2 pictures taken. <ul style="list-style-type: none"> <li>• [Overlay] is only available when [2f] is selected for [Number of Frames].</li> </ul>

- 3 If [On] is selected for [Overlay], you will be prompted to choose a picture for the multiple exposure.
  - Highlight a picture using the arrow pad ( $\Delta$   $\nabla$   $\triangleleft$   $\triangleright$ ) and press the **OK** button.
  - Only RAW images can be selected.
- 4 Press the **OK** button in the multiple exposure menu to save the selected settings.
  - The shooting menu will be displayed.

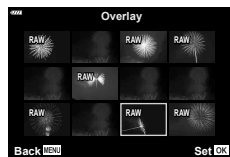



## 5 Press the **MENU** button to exit the menus.



- A  icon will be displayed.
- If [Overlay] is selected, the chosen photograph will be visible superimposed on the view through the lens.



## 6 Take pictures.

- The first shot (or if [Overlay] is selected, the previously-chosen photograph) will be visible superimposed on the view through the lens as you compose the next shot.
- The  icon turns green.
- Normally, a multiple exposure will be created after the second shot is taken.
- Pressing the  button allows you to retake the first shot.
- If [On] is selected for [Overlay], you can take additional pictures that will be overlaid on the previously-chosen photograph.





## 7 Press the **MENU** button or press the button to end multiple exposure photography.

- If you end multiple exposure photography by pressing the **MENU** button, [Off] will be selected for [Number of Frames] in the multiple exposure menu.
- The  icon clears from the display when multiple exposure photography ends.
- The camera will not enter sleep mode during multiple exposure photography.
- Pictures taken with other cameras cannot be used for multiple exposures.
- RAW pictures taken using High Res Shot cannot be used for multiple exposures.
- The RAW pictures listed in the image-selection display when [On] is selected for [Overlay] are those processed using the settings in effect at the time the photograph was taken.
- Exit multiple exposure mode before adjusting shooting settings. Some settings cannot be adjusted while multiple exposure mode is in effect.
- Performing any of the following operations after the first shot is taken ends multiple exposure photography:
  - turning the camera off, pressing the  or **MENU** button, choosing a different shooting mode, or connecting cables of any type. Multiple exposure is also canceled when the battery is exhausted.
- The image-selection display for [Overlay] shows the JPEG copies of photographs taken with RAW + JPEG selected for image quality.
- Live composite photography ([LIVE COMP]) is not available in mode **B**.
- The following are not available in multiple exposure mode:
  - HDR, bracketing, interval-timer photography, keystone compensation, and fisheye correction.
- Pictures taken with RAW selected for  can also be overlaid during playback.

## Keystone correction and perspective control (Keystone Comp.)











Keystone distortion due to the influence of lens focal length and proximity to the subject can be corrected, or enhanced to exaggerate the effects of perspective. Keystone compensation can be previewed in the monitor during shooting. The corrected image is created from a smaller crop, slightly increasing the effective zoom ratio.

- This option is available in **P**, **A**, **S**, **M**, and **B** modes.

- 1 Select [Keystone Comp.] in  Shooting Menu 2, and press the  button.
- 2 Highlight [On], and press the  button.
- 3 Press the **MENU** button to exit the menus.
  - The camera will switch to the keystone compensation display. A slider and  icon be displayed.

Keystone compensation



- 4 Frame the shot and adjust keystone compensation while viewing your subject in the display.
  - Rotate the front dial to make horizontal adjustments and the rear dial to make vertical adjustments.
  - Frame the shot and adjust keystone compensation while viewing your subject in the display.
  - Use the arrow pad (   ) to position the crop. The direction in which the crop can be moved is shown by an arrow ().
  - To cancel changes, press and hold the  button.
- 5 To adjust aperture, shutter speed, and other shooting settings, press the **INFO** button.
  - Standard shooting indicators will be displayed.
  - A  icon is displayed while keystone compensation is enabled. The icon is displayed in green if adjustments have been made to keystone compensation settings.
  - To return to the keystone compensation display shown in Step 4, press the **INFO** button repeatedly.
- 6 Take pictures.
  - Pictures may seem “grainy” depending on the amount of compensation performed. The amount of compensation also determines the amount the picture will be enlarged when cropped and whether the crop can be moved.
  - Depending on the amount of compensation, you may be unable to reposition the crop.
  - Depending on the amount of compensation performed, the selected AF target may not be visible in the display. If the AF target is outside the frame, its direction is indicated by a , , , or  icon in the display.

- Pictures taken with [RAW] for image quality are recorded in RAW + JPEG format.
- The following cannot be used:  
live composite photography, burst photography, bracketing, HDR, multiple exposure, fisheye correction, the digital teleconverter, movie recording, [C-AF] and [C-AF+TR] AF modes, [e-Portrait] and art filter picture modes, the custom self-timer, and High Res Shot.
- Lens converters may not produce the desired results.
- Where applicable, keystone compensation will be performed using the focal length supplied for [Image Stabilizer] (P. 86) or [Lens Info Settings] (P. 196).
- Be sure to provide [Image Stabilizer] data for lenses that are not part of the Four Thirds or Micro Four Thirds family (P. 86).



- [Keystone Comp.] can be assigned to a button. You then need only press the button to enable keystone compensation. [Button Function] (P. 107)

## Setting anti-shock/silent shooting (Anti-Shock [♦]/Silent [♥])









By setting anti-shock/silent shooting, you can select anti-shock or silent shooting when using sequential shooting/self-timer (P. 71).

- 1 Select [Anti-Shock [♦]/Silent [♥]] in Shooting Menu 2 and press the button.
- 2 Use to select the item and press .
  - Use to select the setting and press the button.

<b>Anti-Shock [♦]</b>	Sets the time period between the shutter button being pressed all the way down and the shutter release when shooting in anti-shock mode. Use this mode to suppress small vibrations caused by the operation of the shutter. Anti-shock mode is available in both sequential shooting and self-timer modes (P. 71).
<b>Silent [♥]</b>	Sets the time period between the shutter button being pressed all the way down and the shutter release when shooting in silent mode. Use this option in settings in which the sound of the shutter would be unwelcome. Silent mode supports both the self-timer and sequential shooting (P. 71).
<b>Noise Reduction [♥]</b>	Select [Auto] to reduce image "noise" in long exposures during silent photography. The sound of the shutter may be audible when noise reduction is active.
<b>Silent [♥] Mode Settings</b>	Choose whether to enable [●]), [AF Illuminator], or [Flash Mode] in silent mode. Select [Allow] to use current settings for the selected item, [Not Allow] to ignore current settings and disable the selected item.

## Setting high resolution shooting (High Res Shot)

By specifying the setting for [High Res Shot], high resolution shooting can be activated by selecting  from options for sequential shooting/self-timer mode (P. 71).

- 1 Select [High Res Shot] in  Shooting Menu 2 and press the  button.
- 2 Use   to select the item and press .
  - Use   to select the setting and press the  button.

<b>High Res Shot</b>	Choose how long the camera waits to begin shooting after the shutter button is pressed all the way down. Use this option to prevent blur caused by the camera moving when the shutter button is pressed. Select [Off] to disable High Res Shot.
<b> Charge Time</b>	Choose how the long the camera waits for the flash to charge for High Res Shots taken with the flash. You need not specify a value when using an external flash.

- Electronic shutter is used for high resolution shooting.
-  “Using a flash (Flash photography)” (P. 93)

## Shooting with remote control wireless flash (RC Mode)

Wireless remote-control flash units can be used with the supplied flash unit for wireless remote-control flash photography.  “Wireless remote control flash photography” (P. 216)















## Using the Video Menu









Movie recording functions are set in the Video Menu.



Option	Description	
<b>Mode Settings</b>	[ Mode]: Choose a movie record mode. [ Flicker Scan]: Select [On] to reduce flicker caused by LED lighting. Rotate the front or rear dial or use $\Delta$ $\nabla$ on the arrow pad to choose the shutter speed at which flicker reduction applies.	147
<b>Specification Settings</b>	Sets the image quality for movie recording. [ $\leftarrow$ $\rightarrow$ ]: Set a combination of image quality size and bit rate. [ Noise Filter]: Select a noise reduction level for recording high-sensitivity movies. [ Picture Mode]: Record in a picture mode suitable for editing when set to [On].	149
<b>AF/IS Settings</b>	[ AF Mode]: Choose the AF mode for movie recording. [ Image Stabilizer]: Sets image stabilization for movie recording.	80, 86



















Option	Description	
 <b>Button/Dial/ Lever</b>	<p>Set the button, dial, and lever functions for movie mode.</p> <p> <b>Button Function</b>]: Sets functions to buttons for movie mode.</p> <p> <b>Dial Function</b>]: Sets the functions of the rear dial and front dial for movie mode. If [Exposure ] is assigned to the front or rear dial, exposure compensation is possible up to <math>\pm 3</math> EV (steps of 1/2 and 1 EV are also supported).</p> <p> <b>Fn Lever Function</b>]: Sets functions to be switched by the <b>Fn</b> lever in movie mode. The <b>Fn</b> lever switches to the function set with  <b>Dial Function</b>] when set to [mode1]. To choose the function selected using the <b>Fn</b> lever, highlight [mode2], press , and choose from AF mode, AF target mode, and AF target selection. This setting has no effect when [mode3] is selected for  <b>Fn Lever Function</b>] (P. 164) or when [Power 1] or [Power 2] is selected for [Fn Lever/Power Lever] (P. 164).</p> <p> <b>Shutter Function</b>]: Sets the shutter button function for movie mode. When set to , pressing the shutter button initiates autofocus. Still image photography is not available. When set to , movie recording can be started or stopped by pressing the shutter button all the way down. The  button cannot be used for starting or stopping movie recording with this setting.</p> <p> <b>Elec. Zoom Speed</b>]: Choose the zoom speed for power zoom lenses. This can be used for slow zooms on your subject and other effects. Choose from [Low], [Normal], and [High].</p>	—

Option	Description	
 <b>Display Settings</b>	<p> <b>Control Settings</b>: Sets whether to display Live Control (P. 187) and Live SCP (P. 79) in movie mode. For setting not to display, select the item and press the  button to clear the check mark.</p> <p> <b>Info Settings</b>: Sets the information to be displayed on the movie recording screen. For setting not to display, select the item and press the  button to clear the check mark.</p> <p><b>[Time Code Settings]</b>: Set the time codes to record for movie mode.</p> <p>Set <b>[Time Code Mode]</b> to <b>[Drop Frame]</b> to record time codes corrected for errors with respect to recording time, and to <b>[Non-DF]</b> (no drop frame) to record uncorrected time codes.</p> <p>Set <b>[Count Up]</b> to <b>[Rec Run]</b> to run time codes during recording only, and to <b>[Free Run]</b> to run time codes even while recording is stopped, including when the camera is turned off.</p> <p>In <b>[Starting Time]</b>, set a starting time for the time code. Set <b>[Current Time]</b> to set the time code for the current frame to 00. To set to 00:00:00:00, select <b>[Reset]</b>. You can also set time codes using <b>[Manual Input]</b>.</p>	—
<b>Movie</b> 	Audio will not be recorded in a movie when set to <b>[Off]</b> .	150
 <b>HDMI Output</b>	<p>Sets the output setting for recording movies with this camera connected with an external device via HDMI.</p> <p><b>[Output Mode]</b>: Sets the video output mode. When set to <b>[Monitor Mode]</b>, image and camera information are output. The camera information is not displayed on the camera screen.</p> <p>When set to <b>[Record Mode]</b>, only image is output. The camera information is displayed on the camera screen.</p> <ul style="list-style-type: none"> <li>• This option is not available when a frame size of <b>[4K]</b> or <b>[C4K]</b> is selected for <b>[Specification Settings]</b> &gt;  (P. 149).</li> </ul> <p><b>[REC Bit]</b>: If set to <b>[On]</b>, the REC trigger is sent from the camera to the connected external device.</p> <p><b>[Time Code]</b>: If set to <b>[On]</b>, the time code is sent from the camera to the connected external device.</p> <ul style="list-style-type: none"> <li>• The recording by the external device that uses the time code as the REC trigger may be stopped in the following cases.               <ul style="list-style-type: none"> <li>- When recording an ART movie, etc., under heavy processing load</li> <li>- When switching the display between the monitor and viewfinder</li> </ul> </li> </ul>	—

## Choosing an Exposure Mode (Movie Exposure Modes)

You can create movies that take advantage of the effects available in **P**, **A**, **S**, and **M** modes. This option takes effect when the mode dial is rotated to .

- 1 Select [ Mode Settings] in  Video Menu and press the  button.
- 2 Select [ Mode] (movie exposure modes) and press .
- 3 Use   to select an option and press the  button.

<b>P</b>	Optimal aperture is set automatically according to the brightness of the subject. Use the front dial (  ) or rear dial (  ) to adjust exposure compensation.
<b>A</b>	Depiction of background is changed by setting the aperture. Use the front dial (  ) to adjust exposure compensation and rear dial (  ) to adjust aperture.
<b>S</b>	Shutter speed affects how the subject appears. Use the front dial (  ) to adjust exposure compensation and rear dial (  ) to adjust shutter speed. Shutter speed can be set to values between 1/24 s and 1/32000 s.
<b>M</b>	Aperture and shutter speed can be manually set. Use the front dial (  ) to select aperture value and the rear dial (  ) to select shutter speed. Shutter speed can be set to values between 1/24 s and 1/32000 s. ISO sensitivity can only be set manually to values between 200 and 6400.

- Blurred frames caused by such factors as the subject moving while the shutter is open can be reduced by selecting the fastest available shutter speed.
- The low end of the shutter speed changes according to the frame rate of the movie record mode.
- Excessive camera shake may not be compensated enough.
- When the inside of the camera becomes hot, shooting is automatically stopped to protect the camera.

## Reducing Flicker Under LED Lighting (Flicker Scan)

Banding may occur in movies filmed under LED lighting. Use [Flicker Scan] to optimize shutter speed while viewing banding in the display.

This option is in [Mode] (movie exposure modes) [S] and [M].

- The range of available shutter speeds is reduced.

- 1 Select [S] or [M] for [Mode] (movie exposure modes).
- 2 Highlight [Mode Settings] in the video menu and press the [OK] button.
- 3 Highlight [Flicker Scan] and press [Right Arrow].
- 4 Highlight [On] using the [Up/Down] buttons and press the [OK] button.
- 5 Press the **MENU** button repeatedly to exit the menus.
  - A **Flicker Scan** icon is displayed when flicker scan is enabled.



Flicker Scan icon

- 6 Choose a shutter speed while viewing the display.
  - Choose a shutter speed using the front or rear dial or the [Up/Down] buttons.
  - Continue adjusting shutter speed until banding is no longer visible in the display.
  - Press the **INFO** button; the display will change and the **Flicker Scan** icon will no longer be displayed. You can adjust aperture and exposure compensation. Do so using the front or rear dial or the arrow pad.
  - Press the **INFO** button repeatedly to return to the flicker scan display.



Shutter speed

- 7 Begin filming when settings are complete.
  - Focus peaking, the LV super control panel, and live controls are not available in the flicker scan display. To view these items, first press the **INFO** button to exit the flicker scan display.



- [Flicker Scan] can be assigned to a button. You then need only press the button to enable flicker scan. [Button Function] (P. 107)

## Frame Size, Rate, and Compression



You can set combinations of movie image size and bit rate. The settings can be selected from options of movie record mode (P. 89).











- 1 Select [⏏ Specification Settings] in [⏏ Video Menu] and press the [OK] button.
- 2 Select [⏏ ⏏] and press [▶].
- 3 Use [▲ ▼] to select the item and press [▶].
  - Use [▲ ▼] to select the setting and press the [OK] button.







<b>Image size</b>	Sets the image size to [C4K] (Custom only), [4K], [FHD] (Full HD), or [HD].
<b>Bit rate</b>	Sets the bit rate to [A-I] (All-Intra), [SF] (Super Fine), [F] (Fine), or [N] (Normal). <ul style="list-style-type: none"><li>• When [4K] or [C4K] is set for the image size, you cannot select the bit rate.</li></ul>
<b>Frame rate</b>	Sets the frame rate to [60p], [50p], [30p], [25p], or [24p]. <ul style="list-style-type: none"><li>• [60p] and [50p] are not available in the following situations.<ul style="list-style-type: none"><li>- When [FHD] (Full HD) is set for the image size and [A-I] (All Intra) is set for the bit rate.</li><li>- When [C4K] or [4K] is set for the image size.</li></ul></li><li>• If the image size is set to [C4K], the frame rate is locked to 24p.</li><li>• When shooting movies that will be viewed on a television, choose a frame rate that matches the video standard used in the device, as otherwise the movie may not play back smoothly. Video standards vary by country or region: some use NTSC, others PAL.<ul style="list-style-type: none"><li>- When shooting for display on NTSC devices, choose 60p (30p)</li><li>- When shooting for display on PAL devices, choose 50p (25p)</li></ul></li></ul>
<b>Slow or Fast Motion</b>	Sets slow or fast motion. Available settings differ depending on the set frame rate. <ul style="list-style-type: none"><li>• Slow and fast motions cannot be used in some image quality modes.</li></ul>





## Sound Recording Options

(Movie )

Adjust settings for recording sound during filming. You can also access settings for use when an external microphone or recorder is connected.

- 1 Select [Movie ] in  Video Menu and press the  button.
- 2 Select [On] and press .
- 3 Use   to select the item and press .
  - Use   to select the setting and press the  button.

<b>Recording Volume</b>	Adjust microphone sensitivity. Choose separate values for the built-in stereo microphone and external microphones. [Built-In  ]: Adjust the sensitivity of the camera's built-in stereo microphone. [MIC  ]: Adjust the sensitivity of external microphones connected to the microphone jack.
<b> Volume Limiter</b>	Choose the maximum volume at which the camera will record sound. Use this option to automatically reduce the level of sounds above a certain volume.
<b>Wind Noise Reduction</b>	Reduce wind noise during audio recording.
<b>Recording Rate</b>	Choose an audio recording format. [96kHz/24bit]: High-quality audio. [48kHz/16bit]: Standard-quality audio.
<b> Plug-in Power</b>	Adjust settings for use with condenser microphones and other devices that draw power from the camera. [Off]: For devices that do not require power from the camera (general-purpose dynamic microphones). [On]: For devices that require power from the camera (condenser microphones).
<b>PCM Recorder  Link</b>	Adjust settings for use with external IC recorders. Record a slate tone or choose whether camera controls can be used to start and stop recording when using an Olympus LS-100 IC recorder. [Camera Rec. Volume]: Choose [Operative] to record sound at the level selected with the camera, [Inoperative] to record sound at the level selected with the recorder. [Slate Tone]: Enable or disable slate tone recording. [Synchronized  Rec.]: Choose whether audio recording begins and ends at the same time as movie recording.

- Operation sounds of the lens and camera may be recorded in a movie. To prevent it from recording, reduce the operation sounds by setting [ AF Mode] (P. 80) to [S-AF], [MF], or [PreMF], or by minimizing the button operations of the camera.
- Sound is not recorded:
  - with high-speed or slow- or fast-motion movies or when  (diorama) is selected for picture mode.
- When [Movie ] is set to [Off],  is displayed.
- Audio can only be played on devices that support the option selected for [Recording Rate].

## Using the Olympus LS-100 IC Recorder

When recording audio with an Olympus LS-100 IC recorder, you can use camera controls to record slate tones or to start and stop recording.

Connect the LS-100 using the USB cable and a third-party stereo mini-jack cable. Use a “no resistance” cable.

- Additional information is available in the documentation provided with the LS-100. Be sure the recorder firmware has been updated to the latest version.

### 1 Connect the IC recorder.

- When the LS-100 is connected via the micro USB connector, a message will be displayed prompting you to choose a connection type. Select [PCM Recorder].

- If no message is displayed, adjust menu settings as follows:

**MENU** button → **\*** (custom menu) tab → **D4** tab → [USB Mode] → Select [Auto] or [PCM Recorder]

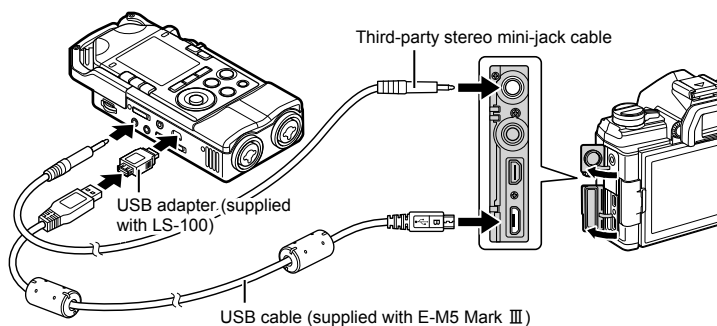

### 2 Adjust [PCM Recorder Link] settings:

- **MENU** button → (video) menu → [Movie ] → [On] → [PCM Recorder Link] → Press **▷** on the arrow pad

[Camera Rec. Volume]: Select [Inoperative].

[Slate Tone]: Select [On].

[Synchronized Rec.]: Select [On].

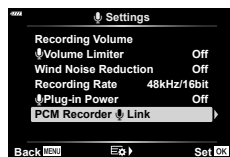

After adjusting settings, check that [On] is selected for [Movie ] and press the **MENU** button repeatedly to exit the menus.

### 3 Start filming.

- The LS-100 will begin recording audio.
- To record a slate tone, press and hold the button.

### 4 End filming.

- The LS-100 will stop recording audio.



- You can choose how long you have to keep the button pressed to record a slate tone.  
 [Press-and-hold Time] (P. 174)
- Disconnect the USB cable when the camera is off or the recorder is not in use.

## 4

### Menu functions (Video menu)



## Using the Playback Menu

### Playback Menu

- 📷 (P. 153)
- Edit (P. 153)
- Print Order (P. 120)
- Reset Protect (P. 158)
- Reset share Order (P. 158)
- Device Connection (P. 201)



### Automatically Rotating Portrait-Orientation Pictures for Playback



If set to [On], images in portrait orientation are automatically rotated to be displayed in the correct orientation on the playback display.



### Retouching Pictures

(Edit)

Create retouched copies of pictures. In the case of RAW pictures, you can adjust the settings in effect at the time the picture was taken, such as white balance and picture mode (art filters included). With JPEG pictures, you can make simple edits such as cropping and resizing.

- 1 Select [Edit] in the 📷 Playback Menu and press the **OK** button.
- 2 Use  $\Delta$   $\nabla$  to select [Sel. Image] and press the **OK** button.
- 3 Use  $\leftarrow$   $\rightarrow$  to select the image to be edited and press the **OK** button.
  - [RAW Data Edit] is displayed if a RAW image is selected, and [JPEG Edit] if a JPEG image is selected. For images recorded in RAW+JPEG format, both [RAW Data Edit] and [JPEG Edit] are displayed. Select the desired option from them.
- 4 Select [RAW Data Edit] or [JPEG Edit] and press the **OK** button.

RAW Data Edit	Creates a JPEG copy of a RAW image according to the selected settings.	
	Current	Retouch pictures and save the resulting copies in JPEG format. Adjust the camera settings before choosing this option. Some settings such as exposure compensation are not applied.
	Custom1	Press <b>OK</b> and adjust settings while previewing the results in the display. The settings are saved as [Custom1] or [Custom2].
	Custom2	
ART BKT	The camera creates multiple JPEG copies of each image, one for each art filter selected. Select one or more filters and apply them to one or more images.	

<b>JPEG Edit</b>	The [JPEG Edit] menu contains the following options.	
	<b>Shadow Adj.</b>	Brighten back-lit subjects.
	<b>Red-eye Fix</b>	Reduce "red-eye" in pictures taken with a flash.
		Crop pictures. Size the crop with the front or rear dial and position it with the arrow pad.
	<b>Aspect</b>	Change the aspect ratio from the standard 4:3 to [3:2], [16:9], [1:1], or [3:4]. After choosing an aspect ratio, use the arrow pad to position the crop.
	<b>Black &amp; White</b>	Create a black-and-white copy of the current picture.
	<b>Sepia</b>	Create a sepia copy of the current picture.
	<b>Saturation</b>	Adjust the vividness of colors. The results can be previewed in the display.
		Create a resized copy 1280 × 960, 640 × 480, or 320 × 240 pixels in size. Pictures with an aspect ratio other than the standard 4:3 are resized to dimensions as close as possible to the selected option.
	<b>e-Portrait</b>	Smooth complexions. The desired effect may not be achieved if no faces are detected.

- Red-eye reduction may not produce the desired results with some pictures.
- Retouch is not available:
  - with pictures that were taken with another camera or edited on a computer or if the space available on the memory card is insufficient.

**5** Press the **[OK]** button when settings are complete.

- The selected settings will be applied.

**6** Press the **[OK]** button again.

- Highlight [Yes] using the **Δ** **∇** buttons and press the **[OK]** button to save the retouched copy.





- To create additional copies from the same original RAW image, highlight [Reset] and press the **[OK]** button. To exit without creating more copies, highlight [No] and press the **[OK]** button.
- Selecting [Reset] displays the retouch menu. Repeat the process from Step 4.
- You can also edit selected pictures during playback.
  - [▶]** button → Display a picture you want to retouch → Press the **[OK]** button to view options → [RAW Data Edit] or [JPEG Edit]
- Red-eye correction may not work depending on the image.
- The image cannot be resized (**[▶]**) to the larger size than the original size.
- **[▶]** (trimming) and [Aspect] can only be used to edit images with an aspect ratio of 4:3 (standard).
- When [ART] is selected for picture mode, [Color Space] (P. 105) will be locked at [sRGB].

Overlay existing RAW photos and to create a new picture. Up to 3 pictures can be included in the overlay.





The results can be modified by adjusting brightness (gain) separately for each picture.



- The overlay is saved in the format currently selected for image quality. Overlays created with [RAW] selected for image quality are saved in RAW format and in JPEG format using the image quality option selected for [◀:2] (P. 171).
- Overlays saved in RAW format can in turn be combined with other RAW images to create overlays containing 4 or more pictures.

**1** Select [Edit] in the  Playback Menu and press the  button.





**2** Use   to select [Image Overlay] and press the  button.

**3** Select the number of images to be overlaid and press the  button.

**4** Use     to select the RAW images to be overlaid.

- Selected pictures are marked with a . To deselect, press the  button again.
- The overlaid image will be displayed if images of the number specified in step 3 are selected.

**5** Adjust the gain for each image to be overlaid.

- Use   to select an image and   to adjust gain.
- Gain can be adjusted in the range 0.1–2.0. Check the results in the monitor.

**6** Press the  button to display the confirmation dialog.



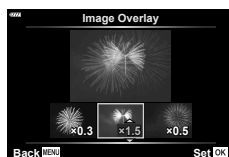
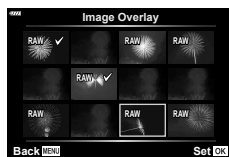













- Select [Yes] and press the  button.



## Creating Movie Stills (In-Movie Image Capture)













Save a still copy of a selected frame.

- This option is available only with [4K] movies recorded with the camera.

- 1** Select [Edit] in the  Playback Menu and press the  button.
- 2** Use   to select [Sel. Image] and press the  button.
- 3** Use   to select a movie and press the  button.
- 4** Select [Movie Edit] and press the  button.
- 5** Use   to select [In-Movie Image Capture] and press the  button.
- 6** Use   to select a frame to be saved as a still image and press the  button.
  - The camera will save a still copy of the selected frame.
  - Use the  button to rewind and the  button to advance.



Cut selected footage from movies. Movies can be trimmed repeatedly to create files containing only footage you want to preserve.

- This option is available only with movies recorded with the camera.

- 1** Select [Edit] in the  Playback Menu and press the  button.
- 2** Use  $\Delta$   $\nabla$  to select [Sel. Image] and press the  button.
- 3** Use  $\triangleleft$   $\triangleright$  to select a movie and press the  button.
- 4** Select [Movie Edit] and press the  button.
- 5** Use  $\Delta$   $\nabla$  to select [Movie Trimming] and press the  button.
  - You will be prompted to choose how you want to save the edited movie.  
[New File]: Save the trimmed movie in a new file.  
[Overwrite]: Overwrite the existing movie.  
[No]: Exit without trimming the movie.
  - If the image is protected, you cannot select [Overwrite].
- 6** Highlight the desired option and press the  button.
  - You will be presented with an edit display.
- 7** Trim the movie.
  - Use the  $\Delta$  button to skip to the first frame and the  $\nabla$  button to skip to the last frame.
  - Using the front or rear dial, select the first frame of the footage you want to delete and press the  button.
  - Using the front or rear dial, highlight the last frame of the footage you want to delete and press the  button.
- 8** Highlight [Yes] and press the  button.
  - The edited movie will be saved.
  - To select different footage, highlight [No] and press the  button.
  - If you selected [Overwrite], you will be prompted to choose whether to trim additional footage from the movie. To trim additional footage, highlight [Continue] and press the  button.



## Removing Protection from All Pictures (Reset Protect)

Protections of multiple images can be canceled at a time.

- 1 Select [Reset Protect] in the  Playback Menu and press the  button.
- 2 Select [Yes] and press the  button.

## Cancelling a share order (Reset share Order)

Cancel share orders that are set on images.

- 1 Select [Reset share Order] in the  Playback Menu and press the  button.
- 2 Select [Yes] and press the  button.

## Using the setup menu

Adjust basic camera settings. Examples include language selection and monitor brightness. The setup menu also contains options used during the initial setup process.



Option	Description	
<b>Card Setup</b>	Format the card and delete all images.	160
(Date/time setting)	Set the camera clock.	27
(Changing the display language)	Choose a language for camera menus and guides.	29
(Monitor brightness adjustment)	<p>You can adjust the brightness and color temperature of the monitor. Color temperature adjustment is only applied to the monitor display during playback. Use <math>\leftarrow</math> <math>\rightarrow</math> to highlight <math>\text{[Color]}</math> (color temperature) or <math>\text{[Bright]}</math> (brightness) and <math>\Delta</math> <math>\nabla</math> to adjust the value.</p> <p>Press the <b>INFO</b> button to switch the saturation of the monitor between <b>[Natural]</b> and <b>[Vivid]</b> settings.</p>	—
<b>Rec View</b>	<p>Sets whether to display the captured image on the monitor after shooting, and the length of time for the display. This is useful for a brief check of the picture you have taken. You can shoot the next shot by pressing the shutter button halfway even while the captured image is displayed on the monitor.</p> <p><b>[0.3sec]–[20sec]</b>: Sets the length of time (seconds) to display the captured image on the monitor.</p> <p><b>[Off]</b>: The captured image is not displayed on the monitor.</p> <p><b>[Auto </b>]: Displays the captured image, and then switches to playback mode. This is useful for erasing a picture after checking it.</p>	—
<b>Wi-Fi/Bluetooth Settings</b>	Adjust settings for connection to Wi-Fi/ <b>Bluetooth</b> -compatible smartphones using the camera's wireless function.	160
<b>Firmware</b>	Displays the firmware versions of the camera and connected accessories. Check the versions when you inquire about the camera or accessories or when you download the software.	—



## Formatting the card

## (Card Setup)

Cards must be formatted with this camera before first use or after being used with other cameras or computers.

All data stored on the card, including protected images, is erased when the card is formatted.

When formatting a used card, confirm there are no images that you still want to keep on the card.  “Usable cards” (P. 211)

- 1 Select [Card Setup] in the  Setup Menu and press the  button.
  - If there is data on the card, menu items appear. Select [Format] and press the .

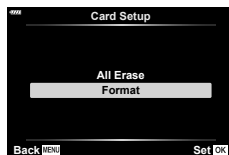





- 2 Select [Yes] and press the  button.
  - Formatting is performed.

## Deleting all images

## (Card Setup)

All images on a card can be deleted at a time. Protected images are not deleted.

- 1 Select [Card Setup] in the  Setup Menu and press the  button.
- 2 Select [All Erase] and press the  button.
- 3 Select [Yes] and press the  button.
  - All images are deleted.

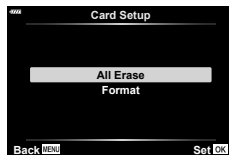

## Wireless LAN Options

## (Wi-Fi/Bluetooth Settings)

Adjust settings for connection to wireless networks. Frame and shoot pictures remotely from a smartphone, or leave the camera off and view pictures on your smartphone while on the road. For information on establishing a connection and using these features, see “5. Connecting the camera to a smartphone” (P. 200).







Availability	Disable Wi-Fi and <b>Bluetooth</b> <sup>®</sup> . Disable Wi-Fi and <b>Bluetooth</b> <sup>®</sup> , for example in settings in which their use is prohibited, without changing network settings (P. 207).
Connection Password	Change the Wi-Fi/ <b>Bluetooth</b> <sup>®</sup> password.
Power-off Standby	Choose whether the camera will connect to smartphones while off.
Reset Settings	Restore defaults for [Wi-Fi/Bluetooth Settings].



## Using the custom menus

Camera settings can be customized using the  Custom Menu.





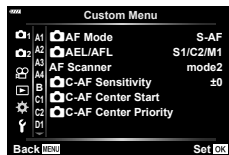

### Custom Menu

- A1/A2/A3/A4** AF/MF (P. 161)
- B** Button/Dial/Lever (P. 164)
- C1/C2** Release//Image Stabilizer (P. 165)
- D1/D2/D3/D4** Disp//PC (P. 166)
- E1/E2/E3** Exp/ISO/BULB/ (P. 169)
- F**  Custom (P. 170)
- G** /WB/Color (P. 171)
- H1/H2** Record/Erase (P. 172)
- I** EVF (P. 173)
- J1/J2**  Utility (P. 174)





### A1 AF/MF











MENU →  → **A1**

Option	Description	
 <b>AF Mode</b>	Choose the AF mode for still image shooting.	80
 <b>AEL/AFL</b>	Customize AF and AE lock.	175
<b>AF Scanner</b>	Choose the type of AF scan* performed in autofocus mode when the camera is unable to focus or the scene lacks contrast. * Scans whole range from minimum range to infinity for focus point when the camera cannot focus on the subject or the contrast is not clear. [mode1]: AF Scanner is not activated. [mode2]: An AF scan is performed only once at the start of the focus operation. [mode3]: AF Scanner is activated.	—
 <b>C-AF Sensitivity</b>	Sets the tracking sensitivity for C-AF.	—
 <b>C-AF Center Start</b>	When used in combination with an AF-target mode other than single target, [C-AF] and [C-AF+TR] focus on the center of the selected group only during the initial scan. During later scans, the camera will focus using the surrounding targets. Combining this option with an AF-target mode that covers a wide area makes it easier to focus on erratically-moving subjects.	177
 <b>C-AF Center Priority</b>	When focusing using group- or custom-target AF in [C-AF] mode, the camera always assigns priority to the center target in the selected group for a repeated series of focus operations. Only if the camera is unable to focus using the center focus target will it focus using the surrounding targets in the selected focus group. This helps you track subjects that are moving quickly but relatively predictably. C-AF center priority is recommended in most situations.	178

Option	Description	Icon
[:::]Mode Settings	Choose the size and shape of the AF target for AF target mode. To hide an item, select the item and press the <b>OK</b> button to clear the check mark.	65
AF Area Pointer	<p>[On1]: Displays the AF target frame in green.            [On2]: Displays the AF target frame in green while the shutter button is pressed halfway.            If you select [Off], the AF target frame will not be displayed during confirmation.</p> <ul style="list-style-type: none"> <li>To enable cluster AF targeting when <b>ALL</b> (all targets) is selected and [S-AF], [S-AF MF], or [C-AF] is chosen for <b>AF Mode</b> (P. 80), select [On2] for [AF Area Pointer]. The camera will display AF targets for all areas that are in focus.</li> </ul>	 —
AF Targeting Pad	<p>If [On] is selected, the AF target can be positioned by tapping the monitor during viewfinder photography. Tap the monitor and slide your finger to position the AF target.</p> <ul style="list-style-type: none"> <li>When set to [On], drag operation can be disabled or enabled by double-tapping the monitor.</li> <li>[AF Targeting Pad] can also be used with zoom frame AF (P. 68).</li> </ul>	—
[:::] Set Home	Choose the home position AF target mode, AF target selection mode, and AF mode. Press the <b>OK</b> button to select the desired options in the [:::] Set Home display. <b>HP</b> appears in the AF target selection display while you choose a home position.	179
[:::] Custom Settings	<p>You can change the dial and <b>Δ ∇ &lt; &gt;</b> button functions for the AF Area screen.</p> <ul style="list-style-type: none"> <li>To use the settings stored in [Set 2], highlight [Set 2] in the [:::] Custom Settings menu and press the <b>OK</b> button.</li> <li>You can switch to [Set 2] by pressing the <b>INFO</b> button in the AF-target selection display.</li> </ul>	—

Option	Description	
<b>AF Limiter</b>	Limits the AF area when turned [On]. [Distance settings]: You can register the AF Limiter area. You can register up to 3 distance areas. Numerical value and unit (m, ft) can be set. The distance is approximate and not exact. [Release Priority]: If [On] is selected, the shutter can be released while AF Limiter is operating even when the camera is not in focus. • AF Limiter is not available in the following cases. - When the focus limiter is enabled on the lens. - When using focus bracketing - While in the movie mode or recording a movie	—
<b>AF Illuminator</b>	Select [Off] to disable the AF illuminator.	—
<b>☺ Face Priority</b>	You can select the face priority or eye priority AF mode.	67
<b>AF Focus Adj.</b>	Focal location adjustment for phase-difference AF can be fine tuned within a range of $\pm 20$ steps.	—



Option	Description	
<b>Preset MF distance</b>	Sets the Preset MF focus position. Numerical value and unit (m, ft) can be set. The distance is approximate and not exact.	—
<b>MF Assist</b>	Automatically switch to zoom or peaking in manual focus mode by rotating the focus ring.	180
<b>MF Clutch</b>	Selecting [Inoperative] prevents the lens MF clutch and snapshot focus being used for manual focus. To focus manually, slide the focus ring forward.	213
<b>Focus Ring</b>	You can customize how the lens adjusts to the focal point by selecting the rotational direction of the focus ring.	—
<b>Bulb/Time Focusing</b>	You can change the focus position during exposure by using manual focus (MF). When set to [Off], rotation of the focus ring is disabled.	180
<b>Reset Lens</b>	When set to [Off], the focus position of the lens is not reset even when the power is turned off. When set to [On], the focus of power zoom lenses is also reset.	—

Option	Description	
 <b>Button Function</b>	Choose the function assigned to the selected button.	107
 <b>Function</b>	Choose the role played by the  button during playback. [  ]: Create or modify a “share order” by marking pictures for upload to a smartphone. [  ]: Select multiple pictures.	—
 <b>Dial Function</b>	You can change the function of the front dial and rear dial.	—
<b>Dial Direction</b>	Choose the direction in which the dial is rotated to adjust shutter speed or aperture. Change the program shift direction in which the dial is rotated.	—
 <b>Fn Lever Function</b>	Choose the function performed by the <b>Fn</b> lever.	181
<b>Fn Lever/Power Lever</b>	Use the <b>Fn</b> lever as a power switch. [Fn]: Follows settings for the <b>Fn</b> lever function. [Power 1]: The power turns on when the <b>Fn</b> lever is in position 1, and off when in position 2. [Power 2]: The power turns on when the <b>Fn</b> lever is in position 2, and off when in position 1. When [Power 1] or [Power 2] is set, the <b>ON/OFF</b> lever (power lever), [  Fn Lever Function] and [  Fn Lever Function] are disabled.	—
 <b>Elec. Zoom Speed</b>	Choose the speed at which power zoom lenses zoom in or out when the zoom ring is rotated. Adjust zoom speed if it is so quick that you find it hard to frame your subject. Choose from [Low], [Normal], and [High].	—

Option	Description	
<b>S-AF Release Priority</b>	If [On] is selected, the shutter can be released even when the camera is not in focus. This option can be set separately for S-AF and C-AF modes (P. 80).	—
<b>C-AF Release Priority</b>		
<b>L Settings</b>	Choose frame advance rates and shot limits for [], [], and [] modes. You can also adjust Pro Capture settings, including the frame advance rate ( only), number of frames buffered, and the shot limit. Figures for sequential shooting speed are the approximate maximums.	182
<b>H Settings</b>		
<b>Flicker Reduction</b>	[Anti-Flicker LV]: Reduce flicker during live view under some kinds of lighting, including fluorescent lamps. If [Auto] does not have the desired effect, select [50 Hz] or [60 Hz] according to the frequency of the local power supply. [Anti-Flicker Shooting]: The camera automatically detects the flicker frequency and times the shutter release accordingly.	184

Option	Description	
<b>Image Stabilizer</b>	Sets image stabilization for still image shooting.	86
<b>Image Stabilizer</b>	Sets the priority function during sequential shooting. [Fps Priority]: Shooting speed gets priority over image stabilization. The sensor will not be reset to the center during sequential shooting. [IS Priority]: Image stabilization gets priority over shooting speed. The sensor will be reset to the center per frame of sequential shooting. The shooting speed will drop slightly.	—
<b>Half Way RIs With IS</b>	When set to [Off], the IS (Image Stabilization) function while the shutter button is pressed halfway will not be activated.	—
<b>Lens I.S. Priority</b>	Select [On] to give priority to lens on-board image stabilization when shooting with third-party lenses. [S-IS ] will be used when [S-IS AUTO] is selected for [ Image Stabilizer] (P. 86). • This option has no effect on lenses that are equipped with an image stabilization switch.	—



Option	Description																																			
<b>Control Settings</b>	Choose the controls displayed in each shooting mode.	186																																		
	<table border="1"> <thead> <tr> <th rowspan="2">Controls</th> <th colspan="4">Shooting mode</th> </tr> <tr> <th></th> <th>P/A/S/M/B</th> <th>ART</th> <th>SCN</th> </tr> </thead> <tbody> <tr> <td>Live Control (P. 187)</td> <td>✓</td> <td>✓</td> <td>✓</td> <td>✓</td> </tr> <tr> <td>Live SCP (P. 79)</td> <td>✓</td> <td>✓</td> <td>✓</td> <td>✓</td> </tr> <tr> <td>Live Guide (P. 49)</td> <td>✓</td> <td>—</td> <td>—</td> <td>—</td> </tr> <tr> <td>Art Menu (P. 55)</td> <td>—</td> <td>—</td> <td>✓</td> <td>—</td> </tr> <tr> <td>Scene Menu (P. 50)</td> <td>—</td> <td>—</td> <td>—</td> <td>✓</td> </tr> </tbody> </table>		Controls	Shooting mode					P/A/S/M/B	ART	SCN	Live Control (P. 187)	✓	✓	✓	✓	Live SCP (P. 79)	✓	✓	✓	✓	Live Guide (P. 49)	✓	—	—	—	Art Menu (P. 55)	—	—	✓	—	Scene Menu (P. 50)	—	—	—	✓
	Controls			Shooting mode																																
				P/A/S/M/B	ART	SCN																														
	Live Control (P. 187)		✓	✓	✓	✓																														
	Live SCP (P. 79)		✓	✓	✓	✓																														
	Live Guide (P. 49)		✓	—	—	—																														
Art Menu (P. 55)	—	—	✓	—																																
Scene Menu (P. 50)	—	—	—	✓																																
Press the <b>INFO</b> button to switch the screen contents.																																				
<b>/Info Settings</b>	Choose the information displayed when the <b>INFO</b> button is pressed. [▶ Info]: Choose the information displayed in full frame playback. [▶ Q Info]: Choose the information displayed in magnified playback. [LV-Info]: Choose the information displayed when the camera is in shooting mode. [Info Settings]: Choose the information displayed in index and calendar playback.	188, 189																																		
<b>Picture Mode Settings</b>	Select a function to display in the picture mode type selection screen (P. 98). To hide an item, select the item and press the  button to clear the check mark.	—																																		
<b>Settings</b>	Select a function to display in the sequential shooting/self-timer function selection screen (P. 71). To hide an item, select the item and press the  button to clear the check mark.	—																																		
<b>Multi Function Settings</b>	Select a multi function (P. 113) option. When not using this option, select the item and press the  button to clear the check mark.	—																																		

Option	Description	
<b>Live View Boost</b>	Shoot while checking the subject even under low-light conditions. In <b>B</b> mode, you can use this setting when shooting with BULB/TIME shooting and live composite. [Off]: Preview exposure in live view. Exposure can be previewed before shooting. <ul style="list-style-type: none"> <li>This option does not apply during bulb or time photography.</li> </ul> [On1]: Exposure preview disabled; brightness is adjusted for ease of viewing. The brightness of the preview differs from the final photograph. [On2]: As for [On1] but brighter. Choose when framing shots of the night sky or the like. <ul style="list-style-type: none"> <li>The brightness of the preview differs from the final photograph. Subject motion may also appear slightly jerky.</li> </ul>	—
<b>Art LV Mode</b>	[mode1]: The filter effect is always displayed. [mode2]: Priority is given to smooth display while the shutter button is pressed halfway. The quality of art filter effect previews may be affected.	—
<b>LV Close Up Settings</b>	[LV Close Up Mode]: When set to [mode1], pressing the button halfway in the magnified live view returns to the magnified frame display. When set to [mode2], pressing the button halfway in the magnified live view switches to the Zoom AF display. [Live View Boost]: If [On] is selected, the camera will adjust display brightness for ease of viewing during focus zoom. When set to [Off], the magnified area is displayed with the brightness of live view before magnification. This is useful to check the focus when shooting in backlit locations.	—
 <b>Default Setting</b>	Choose the starting zoom ratio for playback zoom (close-up playback).	189
 <b>Settings</b>	[Lock]: Select [On] to maintain the aperture at the selected value even when releasing the button. [Live View Boost]: If [On] is selected, the camera will adjust display brightness for ease of viewing during depth-of-field preview.	—

Option	Description	
<b>Grid Settings</b>	Sets the guide line display that appears when shooting. [Display Color]: Sets the guide line color and opacity. Can be set to [Preset 1] and [Preset 2]. [Displayed Grid]: Select [■], [■], [■], [■] or [■] to display a grid on the monitor. [Apply Settings to EVF]: If [On] is selected, the guides shown in the monitor will also be displayed in the viewfinder when [Style 1] or [Style 2] is selected for [EVF Style]. The setting selected in [EVF Grid Settings] will be invalid.	—
<b>Peaking Settings</b>	You can change the edge enhancement color and intensity. The edge enhancement color (red, yellow, white, black) and intensity (Standard, Low, High), and the brightness of the peaking background (On, Off) can be set. • If [Image Brightness Adj.] is set to [On], the brightness of live view is adjusted to enhance the enhancement color.	180
<b>Histogram Settings</b>	[Highlight]: Choose the lower bound for the highlight display. [Shadow]: Choose the upper bound for the shadow display.	188
<b>Mode Guide</b>	Select [On] to display a help for the selected mode when the mode dial is rotated to a new setting.	34
<b>Selfie Assist</b>	Selecting [On] optimizes the display for self-portraits when the monitor is in the self-portrait position.	190

Option	Description	
<b>■) (Beep sound)</b>	When set to [Off], you can turn off the beep sound that is emitted when the focus locks by pressing the shutter button.	—
<b>HDMI</b>	[Output Size]: Selecting the digital video signal format for connecting to a TV via an HDMI cable. [HDMI Control]: Select [On] to allow the camera to be operated using remotes for TVs that support HDMI control. This option takes effect when pictures are displayed on a TV. [Output Frame Rate]: Select the output frame rate from [50p Priority] or [60p Priority] for using the camera connected to a TV with an HDMI cable.	191
<b>USB Mode</b>	Choose a mode for connecting the camera to a computer. Choose [Auto] to display USB mode options every time the camera is connected.	208





Option	Description	
<b>Exposure Shift</b>	Adjust correct exposure separately for each metering mode. <ul style="list-style-type: none"> <li>• This reduces the number of exposure compensation options available in the selected direction.</li> <li>• The effects are not visible in the monitor. To make normal adjustments to the exposure, perform exposure compensation (P. 64).</li> </ul>	—
<b>EV Step</b>	Choose the size of the increments used when selecting shutter speed, aperture, exposure compensation, and other exposure parameters.	—
<b>ISO Step</b>	Select the increments available for choosing ISO sensitivity.	—
<b>ISO-Auto Set</b>	[Upper Limit/Default]: Choose the maximum and default ISO sensitivity used when [AUTO] is selected for ISO. Select [Upper Limit] to choose the maximum sensitivity, [Default] to choose the default sensitivity. The maximum is 6400. [Lowest S/S Setting]: Choose the shutter speed at which the camera starts raising ISO sensitivity automatically in modes <b>P</b> and <b>A</b> . Choose [Auto] to let the camera choose a shutter speed automatically.	—
<b>ISO-Auto</b>	Choose the shooting modes in which [AUTO] ISO sensitivity is available. [P/A/S]: Auto ISO sensitivity selection is available in all modes except <b>M</b> . [All]: Auto ISO sensitivity selection is available in all modes.	—
 <b>Noise Filter</b>	Choose the amount of noise reduction performed at high ISO sensitivities.	—
<b>Noise Reduct.</b>	This function reduces the noise that is generated during long exposures. [Auto]: Noise reduction is performed at slow shutter speeds, or when the internal temperature of the camera has risen. [On]: Noise reduction is performed with every shot. [Off]: Noise reduction off. <ul style="list-style-type: none"> <li>• The time required for noise reduction is shown in the display.</li> <li>• [Off] is selected automatically during sequential shooting.</li> <li>• This function may not work effectively with some shooting conditions or subjects.</li> </ul>	—

Option	Description	
<b>Bulb/Time Timer</b>	Choose the maximum exposure for bulb and time photography.	—
<b>Bulb/Time Monitor</b>	Set the monitor brightness when [BULB], [TIME], or [LIVE COMP] is used.	—
<b>Live Bulb</b>	Choose the display interval during shooting. The number of update times is limited. The frequency drops at high ISO sensitivities. Choose [Off] to disable the display. Tap the monitor or press the shutter button halfway to refresh the display.	192
<b>Live Time</b>		192
<b>Composite Settings</b>	Set an exposure time to be the reference in composite photography.	193
<b>Flicker Scan</b>	Reduce flicker under LED lighting.	194

Option	Description	
<b>Metering</b>	Choose a metering mode according to the scene.	82
<b>AEL Metering</b>	Choose the metering method used to meter exposure when exposure is locked using the <b>AEL/AFL</b> button. This allows you to use metering method when exposure is locked by pressing the shutter button halfway and another when exposure is locked by pressing the <b>AEL/AFL</b> button. [Auto]: Exposure is metered using the method selected for [Metering] (P. 82).	—
<b>[⋮] Spot Metering</b>	Choose whether the [Spot], [Spot Highlight], and [Spot Shadow] spot metering options meter the selected AF target. <ul style="list-style-type: none"> <li>• [☺ Face Priority] turns off automatically.</li> <li>• The selected option takes effect when [ · ] (single target) or [ · ]s (small target) is selected as the AF-target mode (P. 65).</li> </ul>	—

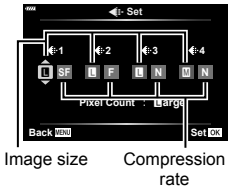
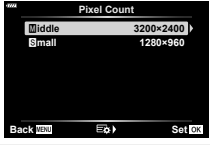
Option	Description	
<b>X-Sync.</b>	Choose the shutter speed used when the flash fires.	195
<b>Slow Limit</b>	Choose the slowest shutter speed available when a flash is used.	195
<b>+ +</b>	When set to [On], the exposure compensation value is added to the flash compensation value.	64, 97
<b>+WB</b>	Adjust white balance for use with a flash.	—

Option	Description	Icon
<p>← Set</p>	<p>You can select the JPEG image quality mode from combinations of three image sizes and three compression rates.</p> <ol style="list-style-type: none"> <li>1) Use &lt;math&gt;\triangleleft \triangleright&lt;/math&gt; to select a combination ([&lt;math&gt;L&lt;/math&gt;]–1) – [&lt;math&gt;S&lt;/math&gt;]–4) and use &lt;math&gt;\triangle \nabla&lt;/math&gt; to change.</li> <li>2) Press the &lt;math&gt;\text{OK}&lt;/math&gt; button.</li> </ol> 	<p>88, 129, 196</p>
<p>Pixel Count</p>	<p>Choose the pixel count for [M]- and [S]-size images.</p> <ol style="list-style-type: none"> <li>1) Select [M]iddle] or [S]mall] and press &lt;math&gt;\triangleright&lt;/math&gt;.</li> <li>2) Choose a pixel count and press the &lt;math&gt;\text{OK}&lt;/math&gt; button.</li> </ol> 	<p>88, 129, 196, 241</p>
<p>Shading Comp.</p>	<p>Choose [On] to correct peripheral illumination according to the type of lens.</p> <ul style="list-style-type: none"> <li>• Compensation is not available for teleconverters or extension tubes.</li> <li>• Noise may be visible at the edges of photographs taken at high ISO sensitivities.</li> </ul>	<p>—</p>
<p>WB</p>	<p>Set the white balance. You can also fine-tune the white balance for each mode.</p>	<p>83</p>
<p>All WB</p>	<p>[All Set]: Use the same white balance compensation in all modes except [CWB]. [All Reset]: Set white balance compensation for all modes except [CWB] to 0.</p>	<p>—</p>
<p>WB AUTO Keep Warm Color</p>	<p>Select [On] to preserve “warm” colors in pictures taken under incandescent lighting.</p>	<p>84</p>
<p>Color Space</p>	<p>You can select a format to ensure that colors are correctly reproduced when shot images are regenerated on a monitor or using a printer.</p>	<p>105</p>

Option	Description	
<p><b>File Name</b></p>	<p>[Auto]: Even when a new card is inserted, the file numbers are retained from the previous card. File numbering continues from the last number used or from the highest number available on the card.</p> <p>[Reset]: When you insert a new card, the folder numbers starts at 100 and the file name starts at 0001. If a card containing images is inserted, the file numbers start at the number following the highest file number on the card.</p>	<p>—</p>
<p><b>Edit Filename</b></p>	<p>Choose how image files are named by editing the portion of the filename highlighted below in gray.</p> <p>sRGB: Pmdd0000.jpg _____ Pmdd</p> <p>Adobe RGB: _mdd0000.jpg _____ mdd</p>	<p>—</p>
<p><b>dpi Settings</b></p>	<p>Choose the print resolution.</p>	<p>—</p>
<p><b>Copyright Settings*</b></p>	<p>Add the names of the photographer and copyright holder to new photographs. Names can be up to 63 characters long.</p> <p>[Copyright Info.]: Select [On] to include the names of the photographer and copyright holder in the Exif data for new photographs.</p> <p>[Artist Name]: Enter the name of the photographer.</p> <p>[Copyright Name]: Enter the name of the copyright holder.</p> <div style="border: 1px solid gray; padding: 10px; margin: 10px 0;"> <p>1) Select characters from ① and press the <b>OK</b> button. The selected characters appear in ②.</p> <p>2) Repeat Step 1 to complete the name, then highlight [END] and press the <b>OK</b> button.</p> <ul style="list-style-type: none"> <li>To delete a character, press the <b>INFO</b> button to place the cursor in the name area ②, highlight the character, and press <b>⏏</b>.</li> </ul> </div>  <p>* OLYMPUS does not accept liability for damages arising from disputes involving the use of [Copyright Settings]. Use at your own risk.</p>	<p>—</p>
<p><b>Lens Info Settings</b></p>	<p>Save lens info for up to 10 lenses that do not automatically supply info to the camera.</p>	<p>196</p>

Option	Description	
<b>Quick Erase</b>	If [On] is selected, pressing the  button in the playback display will immediately delete the current image.	—
<b>RAW+JPEG Erase</b>	Choose the action performed when a photograph recorded at a setting of RAW+JPEG is erased in single-frame playback. [JPEG]: Only the JPEG copy is erased. [RAW]: Only the RAW copy is erased. [RAW+JPEG]: Both copies are erased. • Both the RAW and JPEG copies are deleted when selected images are deleted or when [All Erase] (P. 160) is selected.	88, 119, 129
<b>Priority Set</b>	Choose the default selection ([Yes] or [No]) for confirmation dialogs.	—

## I EVF

Option	Description	
<b>EVF Auto Switch</b>	If [Off] is selected, the viewfinder will not turn on when you put your eye to the viewfinder. Use the  button to choose the display.	—
<b>EVF Adjust</b>	Adjust viewfinder brightness and hue. Brightness is automatically adjusted when [EVF Auto Luminance] is set to [On]. The contrast of the information display is also adjusted automatically.	—
<b>EVF Style</b>	Choose the viewfinder display style.	197
<b>Info Settings</b>	Like the monitor, the viewfinder can be used to display histograms, highlights and shadows, and level gauge. The level gauge is available when [Style 1] or [Style 2] is set in [EVF Style].	—
<b>EVF Grid Settings</b>	Choose the type and color of framing grid displayed in the viewfinder when [Off] is selected for [Grid Settings] > [Apply Settings to EVF] in * Custom Menu  and [Style 1] or [Style 2] is selected for [EVF Style]. Choose the framing grid from .	—
<b>Half Way Level</b>	If set to [Off], the level gauge will not be displayed when the shutter button is pressed halfway down. The level gauge is available when [Style 1] or [Style 2] is set in [EVF Style].	—
<b>S-OVF</b>	Select [On] for a viewfinder display similar to an optical viewfinder. Selecting [S-OVF] makes the details in shadows easier to see. •  is displayed in the viewfinder when [S-OVF] starts. • The display is not adjusted for settings such as white balance, exposure compensation, and picture mode.	—

Option	Description	
<b>Pixel Mapping</b>	The pixel mapping feature allows the camera to check and adjust the image pickup device and image processing functions.	223
<b>Press-and-hold Time</b>	Set the press-and-hold time until the function assigned to the button operates, from [0.5 sec] to [3.0 sec].	—
<b>Level Adjust</b>	You can calibrate the angle of the level gauge. [Reset]: Resets adjusted values to the default settings. [Adjust]: Sets the current camera orientation as the 0 position.	—
<b>Touchscreen Settings</b>	Activate the touch screen. Choose [Off] to disable the touch screen.	—
<b>Menu Recall</b>	Set [Recall] to display the cursor at the last position of operation when you display a menu. The cursor position will be retained even when you turn off the camera.	—
<b>Fisheye Compensation</b>	Correct fisheye distortion when shooting with fisheye lenses.	198

Option	Description	
<b>Backlit LCD</b>	If no operations are performed for the selected period, the backlight will dim to save battery power. The backlight will not dim if [Hold] is selected.	—
<b>Sleep</b>	The camera will enter sleep (energy saving) mode if no operations are performed for the selected period. The camera can be reactivated by pressing the shutter button halfway.	26
<b>Auto Power Off</b>	When in sleep mode, the camera will automatically turn off after the set time has elapsed.	—
<b>Quick Sleep Mode</b>	If [On] is selected, the camera will immediately enter energy-saving mode during viewfinder photography (P. 32), reducing the drain on the battery. You can choose the backlight and sleep times. Energy-saving mode ends when the shutter button is pressed. The camera will not enter energy-saving mode during live view or while the viewfinder is on. An "ECO" icon is displayed in the super control panel when [On] is selected.	—
<b>Certification</b>	Display certification icons.	—

## Setting Focus and Exposure with the AEL/AFL Button



**MENU** → **\*** → **AF** → [**AEL/AFL**]

Autofocus and metering can be performed by pressing the button to which AEL/AFL has been assigned. Choose a mode for each focus mode.

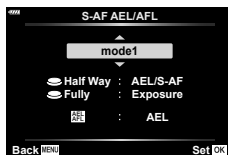



### Assignments of AEL/AFL function

Mode		Shutter button function				AEL/AFL Button function	
		Half-press		Full press		When holding down AEL/AFL	
		Focus	Exposure	Focus	Exposure	Focus	Exposure
S-AF	mode1	S-AF	Locked	-	-	-	Locked
	mode2	S-AF	-	-	Locked	-	Locked
	mode3	-	Locked	-	-	S-AF	-
C-AF	mode1	C-AF start	Locked	Locked	-	-	Locked
	mode2	C-AF start	-	Locked	Locked	-	Locked
	mode3	-	Locked	Locked	-	C-AF start	-
	mode4	-	-	Locked	Locked	C-AF start	-
MF	mode1	-	Locked	-	-	-	Locked
	mode2	-	-	-	Locked	-	Locked
	mode3	-	Locked	-	-	S-AF	-





**MENU** →  → **A1** → [ C-AF Sensitivity]

Choose how rapidly the camera responds to changes in the distance to the subject while focusing with [C-AF] or [C-AF+TR] selected for [ AF Mode]. This can help autofocus track a quickly-moving subject or prevent the camera refocusing when an object passes between the subject and the camera.

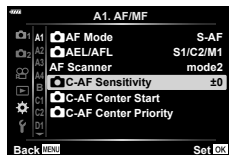
- Choose from five levels of tracking sensitivity.
- The higher the value, the higher the sensitivity. Choose positive values for subjects that suddenly enter the frame, that are moving rapidly away from the camera, or that change speed or stop suddenly while moving toward or away from the camera.
- The lower the value, the lower the sensitivity. Choose negative values to prevent the camera refocusing when the subject is briefly obscured by other objects or to prevent the camera focusing on the background when you are unable to keep the subject in the AF target.

- 1 Highlight [ C-AF Sensitivity] in  Custom Menu **A1** and press the  button.



- 2 Highlight a setting using the   buttons and press the  button.
  -  Custom Menu **A1** will be displayed.

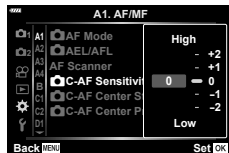

- 3 Press the **MENU** button repeatedly to exit the menus.





## C-AF Starting Focus Target





## ( C-AF Center Start)

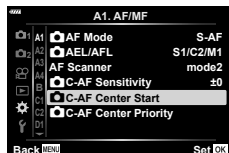

**MENU** →  → **A1** → [ C-AF Center Start]

When used in combination with an AF-target mode other than single target, [C-AF] and [C-AF+TR] focus on the center of the selected group only during the initial scan. During later scans, the camera will focus using the surrounding targets. Combining this option with an AF-target mode that covers a wide area makes it easier to focus on erratically-moving subjects.

- 1 Highlight [ C-AF Center Start] in  Custom Menu **A1** and press the  button.



- 2 Using the   buttons, highlight the AF target modes to which [ C-AF Center Start] will apply and then press the  button.

- Selected modes are marked with a . To deselect, press the  button again.



- 3 Press the **MENU** button repeatedly to exit the menus.

- This option is not available when [ C-AF Center Priority] (P. 178) is enabled.

## C-AF Center Target Priority

( C-AF Center Priority)

**MENU** → → **A1** → [ C-AF Center Priority]

When focusing using group-target AF in [C-AF] mode, the camera always assigns priority to the center target in the selected group for a repeated series of focus operations. Only if the camera is unable to focus using the center focus target will it focus using the surrounding targets in the selected focus group. This helps you track subjects that are moving quickly but relatively predictably. Center priority is recommended in most situations.

- 1 Highlight [ C-AF Center Priority] in Custom Menu **A1** and press the button.

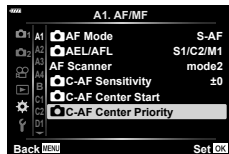

- 2 Using the buttons, highlight the AF target modes to which [ C-AF Center Priority] will apply and then press the button.
  - Selected modes are marked with a . To deselect, press the button again.



- 3 Press the **MENU** button repeatedly to exit the menus.

## MENU → \* → A2 → [[:]] Set Home]

Choose the home position for the [[:]] Home] feature.

The [[:]] Home] feature lets you recall a previously-saved “home position” for autofocus at the touch of a button. This item is used to choose the home position. To access [[:]] Set Home], assign it to a control using [[:]] Button Function] (P. 107).

<b>AF Mode</b>	Choose the home position autofocus mode.
<b>AF Target Mode</b>	Choose the home position AF target mode. Only options selected for [[:]]Mode Settings] (P. 162) are available.
<b>AF Target Point</b>	Choose the home position focus target.

- 1 Highlight [[:]] Set Home] in \* Custom Menu A2 and press the OK button.

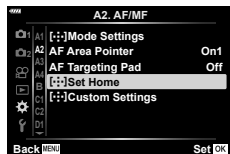

- 2 Highlight a setting you wish to store with the home position and press the OK button.

- Selected items are marked with a ✓. Items marked with a ✓ are included in the home position.

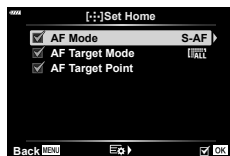

- 3 Press ▸ on the arrow pad to display options for the highlighted setting.

- Choose settings for the home position.

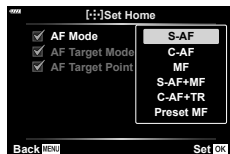

- 4 Press the OK button to save changes when settings are complete.

- The settings list will be displayed.

- 5 Press the MENU button repeatedly to exit when settings are complete.

**MENU** → **⚙** → **A4** → **[MF Assist]**

This is a focus assist function for MF. When the focus ring is rotated, the edge of the subject is enhanced or a portion of the screen display is magnified. When you stop operating the focus ring, the screen returns to the original display.

<b>Magnify</b>	Magnifies a portion of the screen. The portion to be magnified can be set in advance using AF target.  "Choosing a Focus Target (AF Target Point)" (P. 66)
<b>Peaking</b>	Displays clearly defined outlines with edge enhancement. You can select the enhancement color and intensity.  [Peaking Settings] (P. 168)

- [Peaking] can be displayed using button operations. The display is switched every time the button is pressed. Assign the switching function to one of the buttons in advance using Button Function (P. 107).
- Press the **INFO** button to change the color and intensity when Peaking is displayed.
- When Peaking is in use, the edges of small subjects tend to be enhanced more strongly. This is no guarantee of accurate focusing.

**Adjusting Focus During Exposures** (Bulb/Time Focusing)**MENU** → **⚙** → **A4** → **[Bulb/Time Focusing]**

You can adjust focus manually while shooting in **B** (bulb) mode. This allows you to defocus during the exposure or focus at the end of the exposure.

- 1 Highlight [Bulb/Time Focusing] in **⚙** Custom Menu **A4** and press the **OK** button.

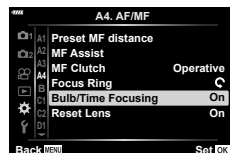



- 2 Highlight an option using the **Δ** **▽** buttons.  
[Off]: The focus position cannot be adjusted manually during an exposure.  
[On]: The focus position can be adjusted manually during an exposure.
- 3 Press the **OK** button to select the highlighted option.
  - **⚙** Custom Menu **A4** will be displayed.
- 4 Press the **MENU** button repeatedly to exit the menu.

## Customizing the Fn Lever Fn Lever Function

### MENU → → **B** → Fn Lever Function]

Choose the role played by the **Fn** lever.

The **Fn** lever can be used to choose the roles of the front and rear dials or to recall focus settings. It can also be used to select movie mode.

This setting takes effect in modes **P**, **A**, **S**, **M**, and **B** (still photography modes). The option selected using [ Fn Lever Function] in the  video menu take effect in  (movie) mode (P. 145).

Mode	Fn lever position 1	Fn lever position 2
Off	The <b>Fn</b> lever function is turned off.	
mode1	Switch the functions of the front and rear dials. The functions for Positions 1 and 2 conform to the setting selected for [  Dial Function] (P. 164).	
mode2	Switch between two groups of settings previously selected for [AF Mode], [AF Target Mode], and [AF Target Point].	
mode3	Sets the shooting mode selected by the mode dial.	Switches to the movie mode.

## Burst Shooting Options



( L Settings / H Settings)

### MENU → ⚙ → → [ L Settings] / [ H Settings]







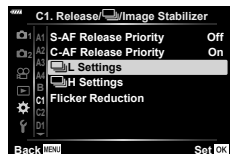

Adjust settings for sequential shooting modes, including the maximum frame advance rate and number of shots per burst. Shooting ends if the maximum number of shots is reached while the shutter button is pressed all the way down.

Choose the advance rate and number of shots per burst for (sequential low) and (sequential high) modes.

<p> L Settings (sequential low options)</p>	<p>Choose the frame rate and maximum number of shots per burst for  (sequential low),  (anti-shock sequential low), and  (silent sequential low) modes. You can also adjust settings for  (Pro Capture Low) mode (P. 75).</p> <ul style="list-style-type: none"> <li> and  modes: [Max fps]: 1–6 fps [Frame Count Limiter]: 2–99, Off (no limit)</li> <li> mode: [Max fps]: 1–10 fps [Frame Count Limiter]: 2–99, Off (no limit)</li> <li> mode: [Pre-shutter Frames]: 0–14 [Frame Count Limiter]: 2–99, Off (no limit) Includes shots captured before recording begins.</li> </ul>
<p> H Settings (sequential high options)</p>	<p>Choose the frame rate and maximum number of shots per burst for  (sequential high) and  (silent sequential high) modes. You can also adjust settings for  (Pro Capture High) mode (P. 75).</p> <ul style="list-style-type: none"> <li> mode: [Max fps]: 5–10 fps [Frame Count Limiter]: 2–99, Off (no limit)</li> <li> mode: [Max fps]: 15, 20, or 30 fps [Frame Count Limiter]: 2–99, Off (no limit)</li> <li> mode: [Max fps]: 15, 20, or 30 fps [Pre-shutter Frames]: 0–14 [Frame Count Limiter]: 2–99, Off (no limit) Includes shots captured before recording begins.</li> </ul>

- 1 Highlight [L Settings] or [H Settings] in  and press the  button.









- 2 Highlight [/] (or, in the case of [], []), [], or [] using   on the arrow pad and press the  button.

- The camera will display options for the selected item.







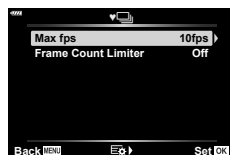

- 3 Choose a setting for [Max fps].

- Highlight [Max fps] using the   buttons and press the  button.
- Highlight an option using the   buttons and press the  button.







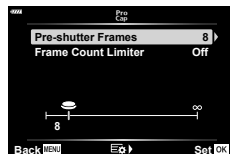





- 4 Choose a setting for [Pre-shutter Frames].

- This option will only be available if you selected [] in Step 2.
- Highlight [Pre-shutter Frames] using the   buttons and press the  button.
- Highlight an option using the   buttons and press the  button.
- To disable pre-capture, select [0].



- 5 Choose the maximum number of shots per burst ([Frame Count Limiter]).

- Highlight [Frame Count Limiter] using the   buttons and press the  button.
- To keep shooting as long as the shutter release button is pressed all the way down, select [Off].
- To choose a maximum number of shots, highlight the current setting and press the  button to display options. Highlight digits using the   buttons and use the   buttons to change.
- The maximum number of shots per burst includes shots captured while the shutter button is pressed halfway.  "Shooting without a release time lag (Pro Capture shooting)" (P. 74)
- Press the  button to save changes to settings.

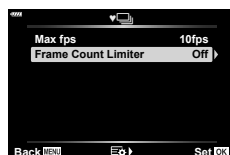

- 6 Press the  button.

-  will be displayed.

- 7 Press the **MENU** button repeatedly to exit the menus.

**MENU** → **⚙** → **C1** → **[Flicker Reduction]**

When shooting under fluorescent or other artificial workplace or outdoor lighting, you may notice flicker in the live view display or uneven exposure in photos taken at fast shutter speeds. This item reduces these effects.

**■ Reducing Flicker in Live View (Anti-Flicker LV)**

Reduce flicker under fluorescent lighting and the like. Choose this option if flicker makes the display difficult to view.

<b>Auto</b>	The camera detects and reduces flicker.
<b>50Hz</b>	Reduce flicker under workplace or outdoor lighting powered by alternating current with a frequency of 50 Hz.
<b>60Hz</b>	Reduce flicker under workplace or outdoor lighting powered by alternating current with a frequency of 60 Hz.
<b>Off</b>	Flicker reduction off. • This option is not available when [On] is selected for [Anti-Flicker Shooting] (P. 185).

- 1** Highlight [Flicker Reduction] in **⚙** Custom Menu **C1** and press the **OK** button.

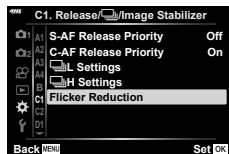

- 2** Highlight [Anti-Flicker LV] using the **Δ** **▽** buttons and press the **▷** button.
- [Anti-Flicker LV] options will be displayed.

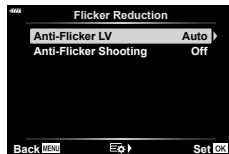

- 3** Highlight an option using the **Δ** **▽** buttons and press the **OK** button.
- [Flicker Reduction] options will be displayed.

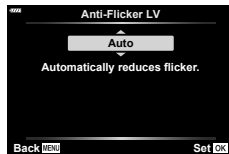

- 4** Press the **MENU** button repeatedly to exit the menus.



## ■ Reducing Flicker in Photographs (Anti-Flicker Shooting)

You may notice uneven exposure in photos taken under flickering light. When this option is enabled, the camera will detect the flicker frequency and adjust the timing of the shutter release accordingly. This feature applies to photos taken with the mechanical shutter.

- 1 Highlight [Flicker Reduction] in Custom Menu and press the button.

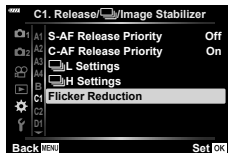

- 2 Highlight [Anti-Flicker Shooting] using the buttons and press the button.
  - [Anti-Flicker Shooting] options will be displayed.

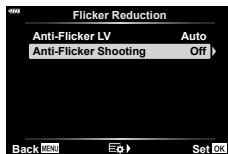

- 3 Highlight [On] or [Off] using the buttons and press the button.
  - [Flicker Reduction] options will be displayed.

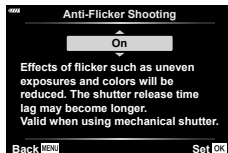

- 4 Press the **MENU** button repeatedly to exit the menus.
  - A icon appears in the display when [On] is selected.



- This option does not take effect in modes that use the electronic shutter, including silent modes, High Res Shot, and Pro Capture modes.
- The camera may be unable to detect flicker at some settings. Normal release timing will be used if flicker is not detected.
- Normal release timing is used at slow shutter speeds.
- Enabling flicker reduction may cause release lag, slowing the frame advance rate during burst photography.

## Choosing the control panel displays (CAMERA Control Settings)

### MENU → → → Control Settings

Sets whether or not to display control panels for option selection in each shooting mode.

In each shooting mode, press the button to insert a check in the control panel you want to display.

#### How to display control panels

- Press the button while the control panel is displayed, then press the **INFO** button to switch the display.
- Only control panels selected in the Control Settings] menu will be displayed.

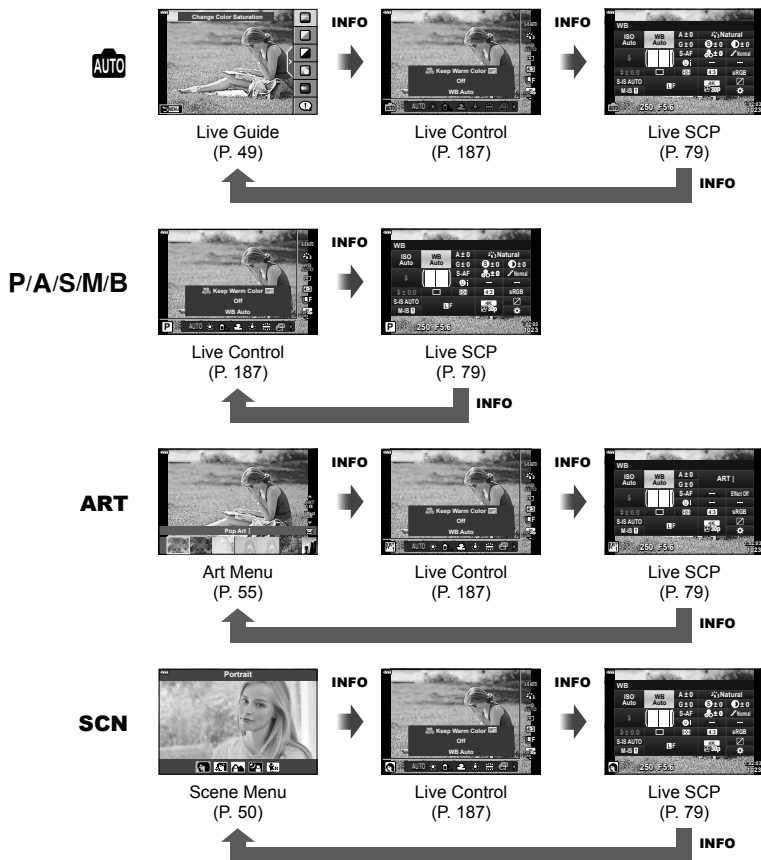

- For movie mode, set with Control Settings] of Display Settings] (P. 146).



**MENU** → **\*** → **[D]** → **[Info Settings]**

## [Info] Info (Playback information displays)

Use **[Info]** to add the following playback information displays. The added displays are displayed by repeatedly pressing the **INFO** button during playback. You can also choose to not show displays that appear at the default setting.



Histogram display



Highlight & Shadow display



Light box display

### Highlight & Shadow display

Areas above the upper limit of brightness for the image are shown in red, those below the lower limit in blue. **[Info]** [Histogram Settings] (P. 168)

### Light box display

Compare two images side-by-side. Press the **[OK]** button to select the base image.

- The base image is displayed on the right. Use the front dial to select an image and press the **[OK]** to move the image to the left. The image to be compared to the image on the left can be selected on the right. To choose a different base image, highlight the right frame and press the **[OK]**.
- To change the zoom ratio, turn the rear dial. Press the **ISO** button and then **[Δ]** **[▽]** **[<]** **[>]** to scroll the zoomed-in area, and rotate the front dial to select between images.



### [Q] Info (Magnified playback information display)

The magnified playback information displays can be set with **[Q] Info**. If **[Q]** (Magnify) is assigned to a button with Button Function (P. 107) in advance, the set displays can be switched by repeatedly pressing the **Q** button during playback. You can also choose to not show displays that appear at the default setting.



### LV-Info (Shooting information displays)

To add highlights and shadows to the [LV-Info] display, press  $\blacktriangleright$  on the arrow pad to place a check next to [Custom1] or [Custom2]. The added displays are displayed by repeatedly pressing the **INFO** button during shooting. You can also choose to not show displays that appear at the default setting.

### Settings (Index/calendar display)

You can change the number of frames to be displayed on the index display and set to not display the screens that are set to be displayed by default with [Settings]. Screens with a check can be selected on the playback screen using the rear dial.

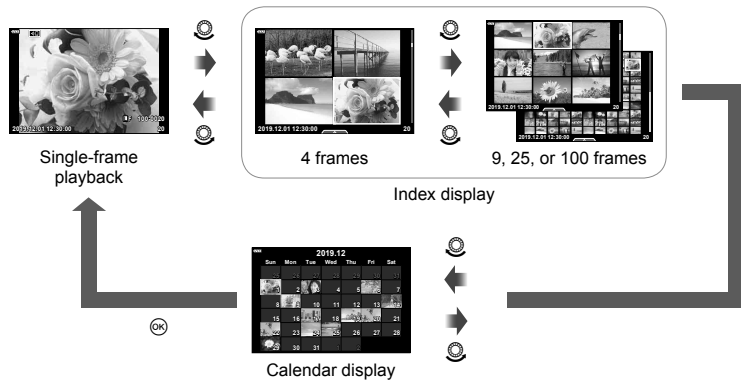



### Choosing the Playback Zoom Ratio (Default Setting)

**MENU** → **⚙** → **D2** → [**🔍** Default Setting]

Choose the starting zoom ratio for playback zoom (close-up playback).

<b>Recently</b>	Zoom in to the most recently selected zoom ratio.
<b>Equally Value</b>	Images are displayed at a zoom ratio of 1:1. A <b>1:1</b> icon appears in the monitor.
<b>×2, ×3, ×5, ×7, ×10, ×14</b>	Choose the starting zoom ratio.

**MENU →  →  → [Selfie Assist]**



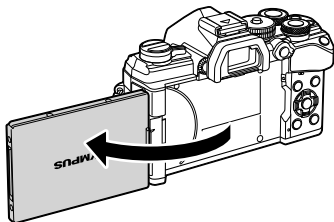

When the monitor is in the selfie position, you can display a convenient touch menu.

- 1 Select [On] for [Selfie Assist] in Custom Menu .
- 2 Turn the monitor towards you.





Self portrait menu

- The self portrait menu is displayed in the monitor.

	<b>One touch e-Portrait</b>	Turning this on makes skin look smooth and translucent. Valid only during AUTO mode (  .
	<b>Touch shutter</b>	When the icon is tapped, the shutter is released about 1 second later.
	<b>One touch custom self-timer</b>	Shoot 3 frames using the self-timer. You can set the number of times the shutter is released and the interval between each release using [Custom Self-timer] (P. 71, 87).

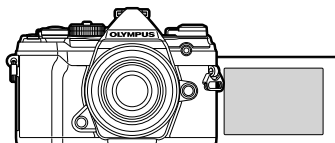
- 3 Frame the shot.
  - Be careful that your fingers or the camera strap do not obstruct the lens.



- 4 Tap  to take the picture.
  - The shot image will be displayed on the monitor.
  - You can also shoot by tapping the subject displayed in the monitor, or by pressing the shutter button.

## Viewing camera images on TV

(HDMI)

### MENU → ⚙ → [D4] → [HDMI]

Use the separately sold cable with the camera to playback recorded images on your TV. This function is available during shooting. Connect the camera to an HD TV using an HDMI cable to view high-quality images on a TV screen.

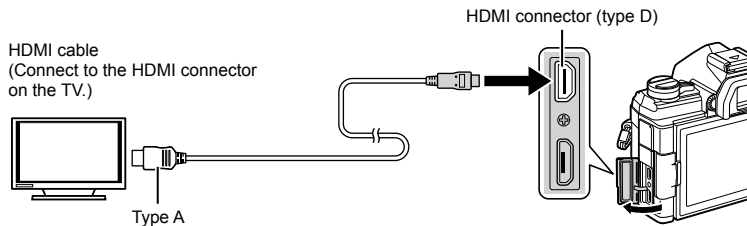

Connect the TV and camera and switch the input source of the TV.

- When an HDMI cable is connected, images are displayed on both the television and the camera monitor. Information is displayed on the television screen only.
- For details on changing the input source of the TV, refer to the TV's instruction manual.
- Depending on the TV's settings, the displayed images and information may become cropped.
- If the camera is connected via an HDMI cable, you will be able to choose the digital video signal type. Choose a format that matches the input format selected with the TV.

<b>C4K</b>	C4K via HDMI output.
<b>4K</b>	Priority is given to 4K HDMI output.
<b>1080p</b>	Priority is given to 1080p HDMI output.
<b>720p</b>	Priority is given to 720p HDMI output.
<b>480p/576p</b>	480p/576p HDMI output.

- Do not connect the camera to other HDMI output devices. Doing so may damage the camera.
- HDMI output is disabled while the camera is connected to a computer via USB.
- When [Record Mode] is selected for [Output Mode] (P. 146), movies will be output at the resolution selected during recording. The images cannot be displayed on the connected TV if the TV does not support the record mode.
- 1080p output will be used in place of [4K] or [C4K] while the camera is being used to take photographs.

### Using the TV remote control

The camera can be operated by a TV remote control when connected to a TV that supports HDMI control.  [HDMI] (P. 168)

The camera monitor turns off.

- You can operate the camera by following the operation guide displayed on the TV.
- During single-frame playback, you can display or hide the information display by pressing the “Red” button, and display or hide the index display by pressing the “Green” button.
- Some televisions may not support all features.

## Live Bulb Update Frequency (Live Bulb)

**MENU** → \* → **E2** → **[Live Bulb]**

Choose the frequency with which the display is updated during live bulb photography in mode **B** (bulb). The display will be refreshed at the selected interval while live bulb photography is in progress, allowing you to view the results in the display.

- [Live Bulb] options can also be displayed by pressing the **MENU** button during [BULB] or [LIVE BULB] photography.

## Live Time Update Frequency (Live Time)

**MENU** → \* → **E2** → **[Live Time]**

Choose the frequency with which the display is updated during live time photography in mode **B** (bulb). The display will be refreshed at the selected interval while live time photography is in progress, allowing you to view the results in the display.

- [Live Time] options can also be displayed by pressing the **MENU** button during [TIME] or [LIVE TIME] photography.



## Choosing the Shutter Speed (Composite Settings)

### MENU → \* → [E2] → [Composite Settings]

The exposure time for each exposure made during live composite photography can be chosen in advance using the menus.

- 1 Highlight [Composite Settings] in \* Custom Menu [E2] and press the [OK] button.

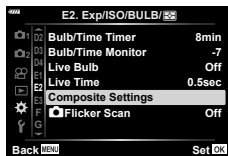

- 2 Highlight an option using the  $\Delta$   $\nabla$  buttons.
  - Choose an exposure time of from 1/2 to 60 s.

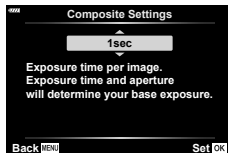

- 3 Press the [OK] button to select the highlighted option.
  - \* Custom Menu [E2] will be displayed.

- 4 Press the **MENU** button repeatedly to exit the menus.

- Live composite photography can continue for up to three hours.
- This item applies during still photography in **B** (bulb) mode. See page P. 47 for more information on composite photography.
- [Composite Settings] options can also be displayed by pressing the **MENU** button in [LIVE COMP] mode.

## Reducing Flicker Under LED Lighting



### MENU → ⚙ → E2 → [📷 Flicker Scan]

Banding may occur in photographs taken under LED lighting. Use [📷 Flicker Scan] to optimize shutter speed while viewing banding in the display.

This item can be used in **S**, **M**, and silent mode and with High Res Shot and Pro Capture shooting.

- The range of available shutter speeds is reduced.

#### 1 Choose shooting and drive modes.

- Choose shooting mode **S** or **M**.
- Choose one of the following drive modes:
  - Silent mode (📷, 📷L, 📷H, 📷2s, 📷2s, or 📷C)
  - High Res Shot (📷)
  - Pro Capture (ProL or ProH)

#### 2 Highlight [📷 Flicker Scan] in ⚙ Custom Menu E2 and press the (OK) button.

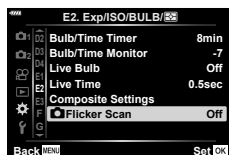

#### 3 Highlight [On] using the Δ ▽ buttons and press the (OK) button.

- The camera will return to the previous menu.



#### 4 Press the **MENU** button repeatedly to exit the menus.

- The camera will exit to the shooting display. A **Flicker Scan** icon will be displayed.



Flicker Scan icon

- 5** Choose a shutter speed while viewing the display.
- Choose a shutter speed using the front or rear dial or the  $\Delta$   $\nabla$  buttons.
  - Continue adjusting shutter speed until banding is no longer visible in the display.
  - Press the **INFO** button; the display will change and the **Flicker Scan** icon will no longer be displayed. You can adjust aperture and exposure compensation. Do so using the front or rear dial or the arrow pad.
  - Press the **INFO** button repeatedly to return to the flicker scan display.

**6** Take pictures once settings have been adjusted to your satisfaction.

- Focus peaking, the LV super control panel, and live controls are not available in the flicker scan display. To view these items, first press the **INFO** button to exit the flicker scan display.



- [ Flicker Scan] can be assigned to a button. You then need only press the button to enable flicker scan. [ Button Function] (P. 107)

### Shutter speeds when the flash fires (⚡ X-Sync./⚡ Slow Limit)

**MENU** → → → [⚡ X-Sync.]/[⚡ Slow Limit]

You can set shutter speed conditions for when the flash fires.

Shooting mode	Flash firing shutter speed	Upper limit	Lower limit
<b>P</b>	The camera automatically sets the shutter speed.	[⚡ X-Sync.] setting	[⚡ Slow Limit] setting*
<b>A</b>			
<b>S</b>	The set shutter speed		No lower limit
<b>M</b>			

\* Extends up to 60 seconds when slow synchronization is set.

## Combinations of JPEG image sizes and compression rates

( Set)

**MENU** → → **G** → [ Set]

You can set the JPEG image quality by combining image size and compression rate.

Image size		Compression rate			Application
Name	Pixel Count	SF (Super Fine)	F (Fine)	N (Normal)	
<b>L</b> (Large)	5184×3888*	<b>L</b> SF*	<b>L</b> F*	<b>L</b> N*	Select for the print size
<b>M</b> (Middle)	3200×2400*	<b>M</b> SF	<b>M</b> F	<b>M</b> N*	
	1920×1440				
<b>S</b> (Small)	1280×960	<b>S</b> SF	<b>S</b> F	<b>S</b> N	For small prints and use on a website
	1024×768				

\* Default

## Saving lens info (Lens Info Settings)

**MENU** → → **II** → [Lens Info Settings]

The camera can store information for up to 10 lenses that do not conform to the Micro Four Thirds or Four Thirds system standards. These data also supply the focal length used for the image stabilization and keystone compensation features.

- 1 Select [Create Lens Information] for [Lens Info Settings] in Custom Menu **II**.
- 2 Select [Lens Name] and enter a lens name. After entering a name, highlight [END] and press the button.
- 3 Use to choose the [Focal Length].
- 4 Use to choose the [Aperture Value].
- 5 Select [Set] and press the button.

- The lens will be added to the lens info menu.
- When a lens that does not supply info automatically is attached, the info used is indicated by . Highlight a lens with a icon and press the button.



- [Lens Info Settings] can be assigned to a button. The button can then be used to recall lens info, for example after lenses are exchanged. [Button Function] (P. 107)

## Selecting the display style of the viewfinder (EVF Style)

**MENU** → **⚙** → **□** → **[EVF Style]**

Style 1/2: Similar to film camera viewfinder displays.

Style 3: The same as the monitor display.



Style 1/ Style 2



Style 3

### ■ Viewfinder display when shooting using the viewfinder (Style 1/Style 2)

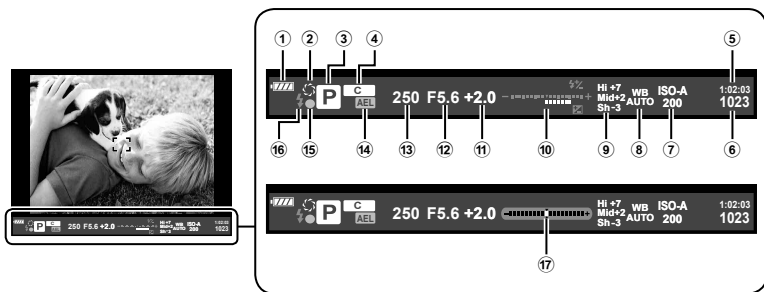

- |  |   |
|--|---|
| <p>① Battery check<br/>  Ready for use.<br/>  Low battery<br/>  Battery is running low.<br/>  Charging required.</p> <p>②  .....P. 108</p> <p>③ Shooting mode..... P. 34–59</p> <p>④ Assign to Custom Mode.....P. 57, 128</p> <p>⑤ Available recording time .....P. 242</p> <p>⑥ Number of storable still pictures ...P. 241</p> <p>⑦ ISO sensitivity .....P. 70, 80</p> <p>⑧ White balance .....P. 83</p> <p>⑨ Highlight&amp;Shadow Control .....P. 106</p> | <p>⑩ Top: Flash intensity control .....P. 97<br/>         Bottom: Exposure compensation indicator .....P. 64</p> <p>⑪ Exposure compensation value.....P. 64</p> <p>⑫ Aperture value ..... P. 37–43</p> <p>⑬ Shutter speed .....P. 37–43</p> <p>⑭ AE Lock <b>[AEL]</b> .....P. 70, 175</p> <p>⑮ AF confirmation mark.....P. 35</p> <p>⑯ Flash (blinks: charging in progress) .....P. 93</p> <p>⑰ Level gauge (displayed by pressing the shutter button down halfway)</p> |
|--|---|

## Correcting Fisheye Distortion (Fisheye Compensation)

### MENU → \* → [ ] → [Fisheye Compensation]

Correct distortion caused by fisheye lenses to give photos the appearance of pictures taken with a wide-angle lens. The amount of correction can be selected from three different levels. You can also opt simultaneously to correct distortion in photos taken under water.

- This option is available in **P**, **A**, **S**, and **M** modes.
- This option is only available with compatible fisheye lenses.

As of July 2019, it could be used with the M.ZUIKO DIGITAL ED 8mm f1.8 Fisheye PRO.

<b>Angle</b>	When fisheye correction is performed, the picture is cropped to eliminate blacked-out areas. Choose from three different crops.
/ <b>Correction</b>	Choose whether to correct distortion in photos taken under water in addition to the correction performed using [Angle].

- 1 Highlight [Fisheye Compensation] in \* Custom Menu [ ] and press the (OK) button.



- 2 Highlight [On] using the Δ ▽ buttons and press the ▷ button.
  - [Angle] and [/ Correction] will be displayed.



- 3 Highlight an item using the Δ ▽ buttons and press the ▷ button.

- Highlight an option using the Δ ▽ buttons and press the (OK) button.
- If you are not taking photos under water, choose [Off] for [/ Correction].
- [Fisheye Compensation] options will be displayed.

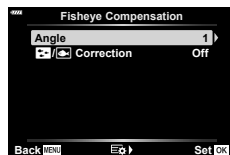

- 4 Press the (OK) button repeatedly to exit to the custom menu.

- After confirming that [On] is selected for [Fisheye Compensation], press the **MENU** button to exit the menus.
- When fisheye compensation is enabled, a icon will be displayed together with the selected crop.



Fisheye compensation



## 5 Take pictures.

- Pictures taken with [RAW] selected for image quality are recorded in RAW + JPEG format. Fisheye compensation is not applied to the RAW image.
- Focus peaking is not available in the fisheye compensation display.
- AF-target selection is restricted to single- and small-target modes.
- The following cannot be used:
  - live composite photography, burst photography, bracketing, HDR, multiple exposure, keystone compensation, the digital teleconverter, movie recording, [C-AF] and [C-AF+TR] AF modes, [e-Portrait] and art filter picture modes, the custom self-timer, and High Res Shot.



- [Fisheye Compensation] can be assigned to a button. You then need only press the button to enable fisheye correction.   Button Function] (P. 107)

Use the camera's wireless LAN (Wi-Fi) and **Bluetooth®** features to connect to a smartphone, where you can use the dedicated app to enhancement your enjoyment of the camera both before and after shooting. Once a connection has been established, you can download and take pictures remotely and add GPS tags to the images on the camera.

- Operation is not guaranteed on all smartphones.

#### Things you can do with the specified app, **OLYMPUS Image Share (OI.Share)**

- Download images from the camera to the smartphone  
You can load images in the camera to a smartphone.  
You can also use the smartphone to select images for download from the camera.
- Remote shooting from a smartphone  
You can remotely operate the camera and shoot using a smartphone.

For details, visit the address below:

<http://app.olympus-imaging.com/oishare/>

#### Things you can do with the specified app, **Olympus Image Palette (OI.Palette)**

- Beautiful image processing  
Use intuitive controls to apply impressive effects to images downloaded to your smartphone.

For details, visit the address below:

<http://app.olympus-imaging.com/oipalette/>

#### Things you can do with the specified app, **OLYMPUS Image Track (OI.Track)**

- Addition of GPS tags to camera images  
You can add GPS tags to images simply by transferring the GPS log saved on the smartphone to the camera.

For details, visit the address below:



<http://app.olympus-imaging.com/oitrack/>

- Before using the wireless LAN function, read "Using the wireless LAN/**Bluetooth®** functions" (P. 249).
- Olympus accepts no responsibility for violations of local regulations governing wireless communications caused by the use of the camera's wireless LAN/**Bluetooth®** features outside the country or region of purchase.
- As with any wireless communication, there is always a risk of interception by a third party. Keep this mind when using wireless LAN.
- The wireless LAN function on the camera cannot be used to connect to a home or public access point.
- The transceiver antenna is located inside the grip. Keep the antenna away from metal objects whenever possible.
- Depending on the composition of the container or the objects it contains, the camera may be unable to connect to a smartphone when placed inside a bag or other container.
- During wireless LAN connection, the battery will run down faster. If the battery is running low, the connection may be lost during a transfer.
- Connection may be difficult or slow in proximity to devices that generate magnetic fields, static electricity or radio waves, such as near microwaves, cordless telephone.
- Wireless LAN cannot be used when the memory card write-protect switch is in the "LOCK" position.



## Adjusting Settings for Connection to a Smartphone

Start the OI.Share App installed on your smartphone.

- 1 Select [Device Connection] in the  Playback Menu and press the  button.
  - You can also connect by tapping  in the monitor.
- 2 Follow the on-screen guide to adjust Wi-Fi/Bluetooth settings.
  - The **Bluetooth** local name and passcode, the Wi-Fi SSID and password, and a QR code are displayed in the monitor.

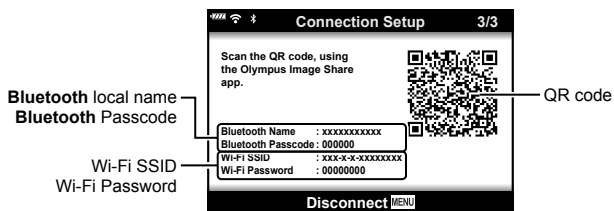

- 3 Tap the camera icon at the bottom of the OI.Share display.
  - An [Easy Setup] tab will be displayed.
- 4 Follow the on-screen instructions in OI.Share to scan the QR code and adjust connection settings.
  - If you are unable to scan the QR code, follow the on-screen instructions in OI.Share to adjust settings manually.
    - **Bluetooth:** To connect, select the local name and enter the passcode displayed in the camera monitor into the **Bluetooth** settings dialog in OI.Share.
    - **Wi-Fi:** Enter the SSID and password displayed by the camera into the Wi-Fi settings dialog displayed by OI.Share.
  -  1 will be displayed when a connection is established.
- 5 To end the connection, press **MENU** on the camera or tap [Disconnect] on the monitor screen.
  - You can also turn the camera off and end the connection from OI.Share.

## Wireless Settings for When the Camera Is Off

You can choose whether the camera will maintain a wireless connection to the smartphone when off.

- 1 Highlight [Wi-Fi/Bluetooth Settings] in the **f** setup menu and press the **OK** button.
- 2 Highlight [Power-off Standby] and press **▷**.
- 3 Highlight the desired option and press the **OK** button.

Select	When you turn the camera off, you will be prompted to choose whether to maintain the wireless connection to the smartphone.
Off	Turning the camera off terminates the wireless connection to the smartphone.
On	When the camera is turned off, the connection to the smartphone remains active and the smartphone can still be used to download or view the pictures on the camera.

### ■ “Select”

When [Select] is chosen for [Power-off Standby], a confirmation dialog will be displayed before the camera turns off if all the following conditions are met:

- [On] is selected for [Availability]
- The camera is currently connected with a smartphone (P. 201)
- The memory card is correctly inserted

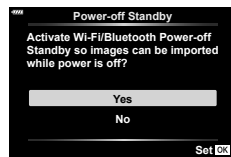

Yes	Turn the camera off but leave the wireless smartphone connection active.
No	Turn the camera off and terminate the wireless smartphone connection.

- If no operations are performed about a minute after the confirmation dialog is displayed, the camera will end the wireless connection to the smartphone and turn off automatically.



- If left active, the wireless connection will automatically terminate if:
  - the connection remains inactive for 12 hours
  - the memory card is removed
  - the battery is replaced
  - a charging error occurs during on-board battery charging



The connection can be restored by turning the camera on.

- Note that if [On] is selected for [Power-off Standby], camera may not turn on immediately when the **ON/OFF** lever is rotated to **ON**.

## Transferring images to a smartphone

You can select images in the camera and load them to a smartphone. You can also use the camera to select images you want to share in advance. (☞ “Selecting Pictures for Sharing (Share Order)” (P. 119))

### 1 Start [Device Connection] on the camera (P. 201).

- You can also connect by tapping  in the monitor.
- Once configured for connection, the camera will connect automatically.
-  1 will be displayed when a connection is established.

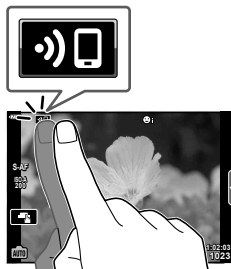

### 2 Launch OI.Share and tap the Image Transfer button.

- The images in the camera are displayed in a list.

### 3 Select the pictures you want to transfer and tap the Save button.

- When saving is completed, you can turn off the camera from the smartphone.



- If the following options are selected for [Wi-Fi/Bluetooth settings] in the camera  (setup) menu, you can download pictures to the smartphone as described in Steps 2 and 3, above, even when the camera is off:
  - [Availability]: [On]
  - [Power-off standby]: [On]

## Automatically uploading images while the camera is off

To configure the camera to automatically upload images to a smartphone while off:

- Mark images for sharing (P. 119)
- Enable power-off standby (P. 202)
- If you are using an iOS device, launch OI.Share



- Auto upload is not available if you are connected via a router (for example, a home network), in which case you will need to transfer pictures using OI.Share.
- Some smartphones may terminate upload on entering sleep mode. Keep the smartphone awake while upload is in progress.

## 5



## Shooting remotely with a smartphone

You can shoot remotely by operating the camera with a smartphone.

- 1** Start [Device Connection] on the camera.
    - You can also connect by tapping  in the monitor.
  - 2** Launch OI.Share and tap the Remote button.
  - 3** Tap the shutter button to shoot.
    - The image taken is saved on the memory card in the camera.
- Available shooting options are partially limited.

## Adding position information to images

You can add GPS tags to images that were taken while the GPS log was saving by transferring the GPS log saved on the smartphone to the camera.

- 1** Before taking pictures with the camera, launch OI.Track on the smartphone to begin saving the GPS log.
  - Before starting a GPS track log, you will need to connect once via OI.Track and synchronize the clock.
  - You can use the phone or other apps while the GPS log is saving. Do not terminate OI.Track.
- 2** Once you have finished taking pictures with the camera, end tracking in OI.Share.
- 3** Tap the  icon in the camera monitor to connect to the smartphone.
  - You can also connect by selecting [Device Connection] in the  playback menu.
- 4** Upload the GPS log to the camera using OI.Track.
  - The GPS log will be used to add location data to any pictures taken after you launched OI.Track in Step 1.
  -  is displayed on images to which position information has been added.
  - Addition of location information can only be used with smartphones that have a GPS function.
  - Position information cannot be added to movies.

## Resetting Wi-Fi/Bluetooth® settings

To restore [Wi-Fi/Bluetooth Settings] to default values:

- 1 Select [Wi-Fi/Bluetooth Settings] in the **f** Setup Menu and press the **OK** button.
- 2 Select [Reset Settings] and press **▷**.
- 3 Select [Yes] and press the **OK** button.
  - The following settings will be reset:

Option	Default
Availability	On
Connection Password	— (generated randomly) *
Power-off Standby	Off *

\* The connection to the smartphone will also be reset (deactivated).

## Changing the password

To change the Wi-Fi/**Bluetooth** passwords:

- 1 Select [Wi-Fi/Bluetooth Settings] in the **f** Setup Menu and press the **OK** button.
  - 2 Select [Connection Password] and press **▷**.
  - 3 Follow the operation guide and press the **OK** button.
    - A new password will be set.
- Both the Wi-Fi connection password and **Bluetooth** connection passcode can be changed.
  - Reconnect to the smartphone after changing passwords.  "Adjusting Settings for Connection to a Smartphone" (P. 201)

## Disabling Wi-Fi/Bluetooth®

To disable wireless LAN/**Bluetooth**®:

- 1** Select [Wi-Fi/Bluetooth Settings] in the **f** Setup Menu and press the **OK** button.
- 2** Select [Availability] and press **▷**.
- 3** Select [Off] and press the **OK** button.



- To disable wireless LAN/**Bluetooth**® only while the camera is off, select [Off] for [Wi-Fi/Bluetooth Settings] > [Power-off Standby].  "Wireless Settings for When the Camera Is Off" (P. 202)

## Connecting the camera to a computer

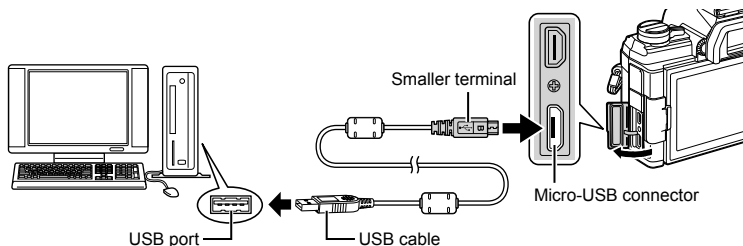

- If nothing is displayed on the camera screen even after connecting the camera to the computer, the battery may be exhausted. Use a full-charged battery.
- The camera should prompt you to choose a host when turned on. If it does not, select [Auto] for [USB Mode] (P. 168) in the camera custom menus.

## Copying pictures to a computer

The following operating systems are compatible with the USB connection:

**Windows:** Windows 7, Windows 8, Windows 8.1, Windows 10

**Mac:** OS X versions 10.9 – 10.11, macOS versions v10.12 – v10.14

- 1 Turn the camera off and connect it to the computer.
  - The location of the USB port varies with the computer. For details, refer to your computer's manual.
- 2 Turn the camera on.
  - The selection screen for the USB connection is displayed.
- 3 Press  $\Delta$   $\nabla$  to select [Storage]. Press the  $\text{OK}$  button.

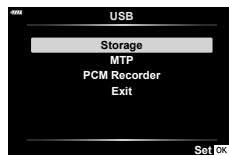

- 4 The computer recognizes the camera as a new device.



- Data transfer is not guaranteed in the following environments, even if your computer is equipped with a USB port.
  - Computers with a USB port added by means of an extension card, etc., computers without a factory-installed OS, or home-built computers
- Camera controls cannot be used while the camera is connected to a computer.
- If the dialog shown in Step 3 is not displayed when the camera is connected to a computer, select [Auto] for [USB Mode] (P. 168) in the camera custom menus.

## Installing the PC software

Install the following software to access the camera while it is connected directly to the computer via USB.

### Olympus Workspace

This computer application is used to download, view, and manage photos and movies recorded with the camera. It can also be used to update the camera firmware. The software can be downloaded from the website below. Be prepared to provide the camera serial number when downloading the software.

<https://support.olympus-imaging.com/owdownload/>

## Battery and charger

- The camera uses a single Olympus lithium-ion battery. Never use any battery other than genuine OLYMPUS batteries.
- The camera's power consumption varies widely with usage and other conditions.
- As the following consume a lot of power even without shooting, the battery will be drained quickly.
  - Performing auto focus repeatedly by pressing the shutter button halfway in shooting mode.
  - Displaying images on the monitor for a prolonged period.
  - When connected to a computer.
  - Leaving wireless LAN/**Bluetooth**® enabled.
- When using a drained battery, the camera may turn off without the low battery warning being displayed.
- The battery will not be fully charged at the time of purchase. Charge the battery using the provided charger before use.
- Remove the batteries before putting the camera into storage for periods of a month or more. Leaving the batteries in the camera for extended periods shortens their lives, potentially rendering them unusable.
- The normal charging time using the supplied charger is approximately 3 hours and 30 minutes (estimated).
- Do not attempt to use chargers not specifically designated for use with the supplied battery, or to use batteries not specifically designated for use with the supplied charger.
- There is a risk of explosion if the battery is replaced with the incorrect battery type.
- Dispose of the used battery following the instructions "CAUTION" (P. 248) in the instruction manual.

## Using your charger abroad

- The charger can be used in most home electrical sources within the range of 100 V to 240 V AC (50/60 Hz) around the world. However, depending on the country or area you are in, the AC wall outlet may be shaped differently and the charger may require a plug adapter to match the wall outlet.
- Do not use commercially available travel adapters as the charger may malfunction.

## Usable cards

In this manual, all storage devices are referred to as “cards”. The following types of SD memory card (commercially available) can be used with this camera: SD, SDHC, and SDXC. For the latest information, please visit the Olympus website.



### SD card write protect switch

The SD card body has a write protect switch. Setting the switch to “LOCK” prevents data being written to the card. Return the switch to the unlock position enable writing.

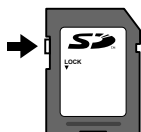

- The data in the card will not be erased completely even after formatting the card or deleting the data. When discarding, destroy the card to prevent leakage of personal information.
- Access to some playback functions and the like may be restricted when the write-protect switch is in the “LOCK” position.

## Interchangeable lenses

Choose a lens according to the scene and your creative intent. Use lenses designed exclusively for the Micro Four Thirds system and bearing the M.ZUIKO DIGITAL label or the symbol shown at right. With an adapter, you can also use Four Thirds System and OM System lenses. The optional adapter is required.



- When you attach or remove the body cap and lens from the camera, keep the lens mount on the camera pointed downward. This helps prevent dust and other foreign matter from getting inside the camera.
- Do not remove the body cap or attach the lens in dusty places.
- Do not point the lens attached to the camera toward the sun. This may cause the camera to malfunction or even ignite due to the magnifying effect of sunlight focusing through the lens.
- Be careful not to lose the body cap and rear cap.
- Attach the body cap to the camera to prevent dust from getting inside when no lens is attached.

### ■ Lens and camera combinations

Lens	Camera	Attachment	AF	Metering
Micro Four Thirds system lens	Micro Four Thirds system camera	Yes	Yes	Yes
Four Thirds system lens		Attachment possible with mount adapter	Yes*1	Yes
OM System lenses			No	Yes*2

\*1 AF is not operational when recording movies.

\*2 Accurate metering is not possible.

## MF Clutch Lenses

The “MF clutch” (manual focus clutch) mechanism on MF clutch lenses can be used to switch between auto and manual focus simply by repositioning the focus ring.

- Check the position of the MF clutch before shooting.
- Sliding the focus ring to the AF/MF position at the end of the lens selects autofocus, while sliding it to the MF position closer to the camera body selects manual focus, regardless of the focus mode chosen with the camera.

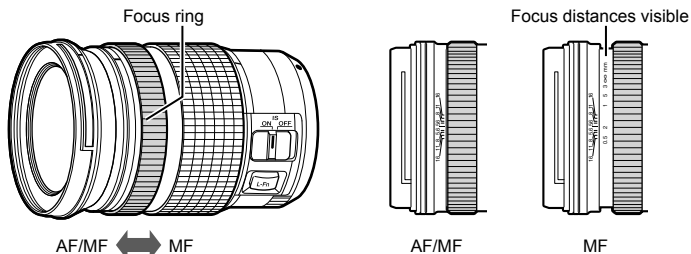

- Selecting [MF] or [PreMF] for focus mode on the camera disables autofocus even when the focus ring is in the AF/MF position.

## Optional Accessories

### Grip (ECG-5)

The grip helps you keep the camera steady when using large lenses. Make sure to turn the camera off when attaching and removing the grip.

#### ■ Part names

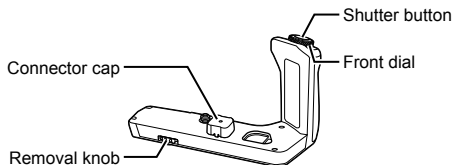

#### ■ Attaching the Grip

Before attaching the grip, remove the connector cover (a) from the bottom of the camera and the connector cap (b) from the ECG-5. Once attached, make sure the ECG-5 removal knob is tightly secured. Be sure to replace the connector cover on the camera when the ECG-5 is not in use.

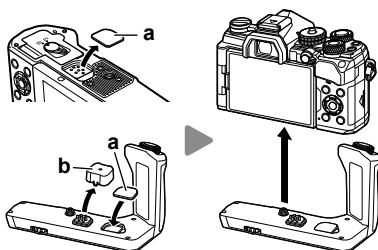

Store the connector cover (a) in the ECG-5

#### ■ Main Specifications (ECG-5)

Dimensions	Approx. 128.4 mm(W) × 76 mm(H) × 60.2 mm(D) (5.1" × 3.0" × 2.4")
Weight	Approx. 121 g (4.3 oz.) (excluding battery and terminal cap)
Splash resistance (when attached to camera)	Type Equivalent to IEC Standard publication 60529 IPX1

- Do not use your nail to turn the removal knob. Doing so could result in injury.
- Only use the camera within the guaranteed operating temperature range.
- Do not use or store the product in dusty or humid areas.
- Do not touch the electrical contacts.
- Use a dry, soft cloth to clean the terminals. Do not clean the product with a damp cloth, thinner, benzene, or any other organic solvents.

## Designated External Flash Units

When using a flash unit designed for use with the camera, you can choose the flash mode using camera controls and take pictures with the flash. See the documentation provided with the flash unit for information on flash features and their use.

Choose a flash unit to suit your needs, taking into consideration such factors as the output required and whether the unit supports macro photography. Flash units designed to communicate with the camera support a variety of flash modes, including TTL auto and super FP. Flash units can be mounted on the camera hot shoe or connected using a cable (available separately) and flash bracket. The camera also supports the following wireless flash control systems:

### **Radio-Controlled Flash Photography: CMD, ⚡CMD, RCV, and X-RCV Modes**

The camera controls one or more remote flash units by means of radio signals. The range of locations in which flash units can be placed increases. Flash units can control other compatible units or be fitted with radio commander/receivers to allow the use of units that do not otherwise support radio flash control.

### **Wireless Remote-Control Flash Photography: RC Mode**

The camera controls one or more remote flash units by means of optical signals. The flash mode can be selected using camera controls (P. 97).

### ■ Features Available with Compatible Flash Units

Flash unit	Supported flash control modes	GN (Guide Number, ISO 100)	Supported wireless systems
FL-700WR	TTL-AUTO, MANUAL, FP TTL AUTO, FP MANUAL, MULTI, RC, SL MANUAL	GN 42 (75/150 mm <sup>*1</sup> ) GN 21 (12/24 mm <sup>*1</sup> )	CMD, ⚡CMD, RCV, X-RCV, RC
FL-900R	TTL-AUTO, AUTO, MANUAL, FP TTL AUTO, FP MANUAL, MULTI, RC, SL AUTO, SL MANUAL	GN 58 (100/200 mm <sup>*1</sup> ) GN 27 (12/24 mm <sup>*1</sup> )	RC
FL-600R		GN 36 (42.5/85 mm <sup>*1</sup> ) GN 20 (12/24 mm <sup>*1</sup> )	RC
STF-8	TTL-AUTO, MANUAL, RC <sup>*2</sup>	GN 8.5	RC <sup>*2</sup>

\*1 Maximum lens focal length at which unit can provide flash coverage (figures following slashes are 35 mm format equivalent focal lengths).

\*2 Functions as commander (transmitter) only.

## Wireless remote control flash photography

Wireless flash photography is available with compatible flash units that support wireless remote control (RC). The remote flash units are controlled via a unit mounted on the camera hot shoe. Settings can be adjusted separately for the camera-mounted unit and units in up to three other groups.

RC mode must be enabled on both the master and remote flash units.

### ■ Enabling RC Mode

- 1 Set the remote flash units to RC mode and place them as desired.
  - Turn the external flash units on, press the **MODE** button, and select RC mode.
  - Select a channel and group for each external flash unit.
- 2 Select [On] for [**RC Mode**] in **Shooting Menu 2** (P. 127), and press the **OK** button.
  - The camera will exit to the shooting display.
  - An **RC** icon will be displayed.



- 3 Press the **OK** button.
  - The RC mode super control panel will be displayed.
  - The standard LV super control panel can be displayed by pressing the **INFO** button. The display will change each time the **INFO** button is pressed.



RC mode super control panel



#### 4 Adjust flash settings.

- Highlight items using the  $\Delta$   $\nabla$   $\langle$   $\rangle$  buttons and rotate the rear dial to choose settings.



<b>Group</b>	Choose a group. Changes to settings apply to all units in the selected group. Choose $\text{☑}$ to adjust settings for the unit mounted on the camera.
<b>Flash control mode</b>	Choose a flash mode.
<b>Flash compensation</b>	Adjust flash output. When [Manual] is selected for flash mode, you can a value for manual flash output.
<b>Optical signal strength</b>	Choose the brightness of the optical control signals emitted by the flash units. Choose [HI] if you have placed flash units at close to the maximum distance from the camera. This setting applies to all groups.
<b>Flash mode/ flash level</b>	Choose $\text{⚡}$ (standard) or FP (super FP). Choose super FP for shutter speeds faster than the flash sync speed. This setting applies to all groups.
<b>Channel</b>	Choose the channel used for flash control. Change the channel if you find that other light sources in the area are interfering with remote flash control.

#### 5 Set the unit mounted on the camera to [TTL AUTO].

- Flash control settings for the FL-LM3 can only be adjusted using the camera.

#### ■ Positioning Remote Flash Units

##### 1 Set the wireless RC flash units to RC mode.

- After turning compatible flash units on, press the **MODE** button and choose RC mode.
- Choose a group for each of the compatible flash units using flash controls and match the channel to that selected with the camera.

##### 2 Position the flash units.

- Position the wireless units with the remote sensors facing the camera.

##### 3 Take pictures after confirming that the remote units and the unit on the camera are charged.

## ■ Wireless Flash Control Range

The illustration is intended as a guide only. The flash control range varies with the type of flash mounted on the camera and the conditions in the surrounding area.

### Flash Control Range for Camera-Mounted FL-LM3 Flash Units

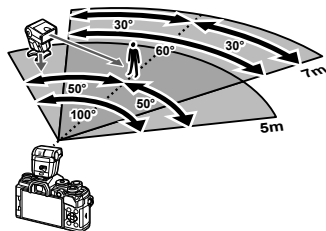

- We recommend that each group contain no more than 3 flash units.
- Wireless flash photography is not available in anti-shock mode or in rear-curtain slow sync mode when a shutter speed slower than 4 s is selected.
- Start wait times longer than 4 s cannot be selected in anti-shock and silent modes.
- Flash control signals may interfere with exposure if subject is too close to the camera. This can be mitigated by reducing the brightness of the camera flash, for example by using a diffuser.

## Other external flash units

Note the following when using a third-party flash unit mounted on the camera hot shoe:

- Using obsolete flash units that apply currents of more than about 24 V to the X-contact will damage the camera.
- Connecting flash units with signal contacts that do not conform to Olympus specifications may damage the camera.
- Set the Shooting mode to **M**, set the shutter speed to a value no higher than flash synchronous speed, and set ISO sensitivity to a setting other than [AUTO].
- Flash control can only be performed by manually setting the flash to the ISO sensitivity and aperture values selected with the camera. Flash brightness can be adjusted by adjusting either ISO sensitivity or aperture.
- Use a flash with an angle of illumination suited to the lens. Angle of illumination is usually expressed using 35-mm format equivalent focal lengths.

## Principal Accessories

### ■ Remote cable (RM-CB2)

Use when the slightest camera movement can result in blurred pictures, for example for macro or bulb photography. Connect the cable to the camera remote cable terminal (P. 14).

### ■ Converter lenses

Converter lenses attach to the camera lens for quick and easy fish-eye or macro photography. See the OLYMPUS website for information on the lenses that can be used.

### ■ Eyecup (EP-16)

You can switch to a large-size eyecup.

#### Removal

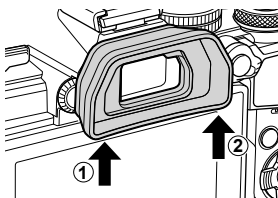

## System chart

### Power Supply



**BLS-50**  
Lithium-ion battery

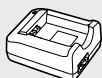

**BCS-5**  
Lithium-ion Charger



**F-5AC**  
USB-AC Adapter

### Viewfinder



**EP-16**  
Eyecup

### Remote Operation

**RM-CB2**  
Remote Cable

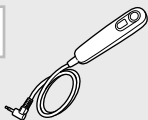

### Grip

**ECG-5**  
Grip

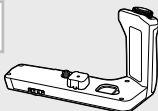

### Case / Strap

Shoulder Strap /  
Camera Case

### Connection Cable

USB Cable /  
HDMI Cable\*\*

### Memory Card

SD/SDHC/  
SDXC

## E-M5 Mark III

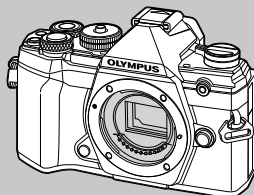

### Microphone

### Software

**Olympus Workspace**  
Digital Photo Managing Software

 : E-M5 Mark III compatible products

 : Commercially available products

For the latest information, please visit the Olympus website.

\*1 HDMI cables are available from third-party suppliers.

\*2 There are restrictions on the lenses that can be used with the adapter. Visit the OLYMPUS website for details.

\*3 Visit the OLYMPUS website for information on compatible lenses.

## Lens



Micro Four Thirds system lenses



MMF-2/MMF-3<sup>2</sup>  
Four Thirds Adapter



Four Thirds system  
lenses

## Converter Lens\*3

**FCON-P01**  
Fisheye

**WCON-P01**  
Wide

**MCON-P01**  
Macro

**MCON-P02**  
Macro

## Flash



**FL-LM3**  
Electronic Flash



**FL-900R**  
Electronic Flash



**FL-700WR**  
Electronic Flash

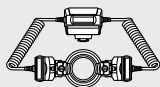

**STF-8**  
Macro Flash



**FC-WR**  
Wireless radiowave  
commander



**FR-WR**  
Wireless radiowave receiver

## Cleaning and storing the camera

### Cleaning the camera

Turn off the camera and remove the battery before cleaning the camera.

- Do not use strong solvents such as benzene or alcohol, or a chemically treated cloth.

#### Exterior:

- Wipe gently with a soft cloth. If the camera is very dirty, soak the cloth in mild soapy water and wring well. Wipe the camera with the damp cloth and then dry it with a dry cloth. If you have used the camera at the beach, use a cloth soaked in clean water and well wrung.

#### Monitor:

- Wipe gently with a soft cloth.

#### Lens:

- Blow dust off the lens with a commercially available blower. For the lens, wipe gently with a lens cleaning paper.

### Storage

- When not using the camera for a prolonged period, remove the battery and card. Store the camera in a cool, dry place that is well ventilated.
- Insert the battery periodically and test the camera's functions.
- Remove dust and other foreign matter from the body and rear caps before attaching them.
- Attach the body cap to the camera to prevent dust from getting inside when no lens is attached. Be sure to replace the front and rear lens caps before putting the lens away.
- Clean the camera after use.
- Do not store with insect repellent.
- Avoid storing the camera in places where chemicals are treated, in order to protect the camera from corrosion.
- Mold may form on the lens surface if the lens is left dirty.
- Check each part of the camera before use if it has not been used for a long time. Before taking important pictures, be sure to take a test shot and check that the camera works properly.

## Cleaning and checking the image pickup device

This camera incorporates a dust reduction function to keep dust from getting on the image pickup device and to remove any dust or dirt from the image pickup device surface with ultrasonic vibrations. The dust reduction function operates when the camera is turned on.

The dust reduction function operates at the same time as the pixel mapping, which checks the image pickup device and image processing circuitry. Since dust reduction is activated every time the camera's power is turned on, the camera should be held upright for the dust reduction function to be effective.

## Pixel Mapping - Checking the image processing functions

The pixel mapping feature allows the camera to check and adjust the image pickup device and image processing functions. After using the monitor or taking continuous shots, wait for at least one minute before using the pixel mapping function to ensure that it operates correctly.

- 1 In Custom Menu **[1]**, select [Pixel Mapping] (P. 174).
  - 2 Press **[▶]**, then press the **[OK]** button.
    - The [Busy] bar is displayed when pixel mapping is in progress. When pixel mapping is finished, the menu is restored.
- If you accidentally turn the camera off during pixel mapping, start again from Step 1.

## Shooting tips and information

### The camera does not turn on even when a battery is loaded

#### The battery is not fully charged



- Charge the battery with the charger.

#### The battery is temporarily unable to function because of the cold

- Battery performance drops at low temperatures. Remove the battery and warm it by putting it in your pocket for a while.

### No picture is taken when the shutter button is pressed

#### The camera has turned off automatically

- If power saving is enabled, the camera will enter sleep mode if no operations are performed for a set period. Press the shutter button halfway to exit the sleep mode.
- The camera automatically enters sleep mode to reduce the drain on the battery if no operations are performed for a set period of time.  [Sleep] (P. 174)  
If no operations are performed for a set time after the camera has entered sleep mode, the camera will turn off automatically.  [Auto Power Off] (P. 174)

#### The flash is charging

- On the monitor, the  mark blinks when charging is in progress. Wait for the blinking to stop, then press the shutter button.

#### Unable to focus

- The camera cannot focus on subjects that are too close to the camera or that are not suited to autofocus (the AF confirmation mark will blink in the monitor). Increase the distance to the subject or focus on a high contrast object at the same distance from the camera as your main subject, compose the shot, and shoot.

#### Subjects that are difficult to focus on

It may be difficult to focus with auto focus in the following situations.

AF confirmation mark is blinking. These subjects are not focused.

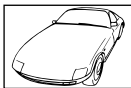

Subject with low contrast



Excessively bright light in center of frame

AF confirmation mark lights up but the subject is not focused.



Subjects at different distances

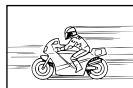

Fast-moving subject



Subject not inside AF area



### Noise reduction is activated

- When shooting night scenes, shutter speeds are slower and noise tends to appear in images. The camera activates the noise-reduction process after shooting at slow shutter speeds. During which, shooting is not allowed. You can set [Noise Reduct.] to [Off].  
 [Noise Reduct.] (P. 169)

### The number of AF targets is reduced

The size and number of the AF target changes depending on the [Digital Tele-converter] (P. 130), [Image Aspect] (P. 87), and group target (P. 65) settings.

### The date and time has not been set

#### The camera is used with the settings at the time of purchase

- The date and time of the camera is not set when purchased. Set the date and time before using the camera.  "Initial setup" (P. 27)

#### The battery has been removed from the camera

- The date and time settings will be returned to the factory default settings if the camera is left without the battery for approximately 1 day. The settings will be canceled more quickly if the battery was only loaded in the camera for a short time before being removed. Before taking important pictures, check that the date and time settings are correct.

### Set functions are restored to their factory default settings

Options selected in **AUTO** () or **SCN** mode are reset when the mode dial is rotated to another setting or the camera is turned off. In addition, selecting **C** mode restores custom mode settings.

### Image taken appears whitish

This may occur when the picture is taken in backlight or semi-backlight conditions. This is due to a phenomenon called flare or ghosting. As far as possible, consider a composition where strong light source is not taken in the picture. Flare may occur even when a light source is not present in the picture. Use a lens hood to shade the lens from the light source. If a lens hood does not have effect, use your hand to shade the lens from the light.

 "Interchangeable lenses" (P. 212)

### Unknown bright dot(s) appear on the subject in the picture taken

This may be due to stuck pixel(s) on the image pickup device. Perform [Pixel Mapping].

If the problem persists, repeat pixel mapping a few times.  "Pixel Mapping - Checking the image processing functions" (P. 223)

### Functions that cannot be selected from menus

Some items may not be selectable from the menus when using the arrow pad.

- Items that cannot be set with the current shooting mode.
- Items that cannot be set because of an item that has already been set:  
Combinations of [] (P. 71) and [Noise Reduct.] (P. 169), etc.

## The subject appears distorted

---

The following functions use an electronic shutter:

movie recording (P. 58), silent mode (P. 74), Pro Capture shooting (P. 74), High Res Shot (P. 76), focus bracketing (P. 134), focus stacking (P. 134)



This may cause distortion if the subject is moving rapidly or the camera is moved abruptly. Avoid moving the camera abruptly during shooting or use standard sequential shooting.

## Lines appear in photographs







---





The following functions use an electronic shutter, which may result in lines due to flicker and other phenomena associated with fluorescent and LED lighting, an effect that can sometimes be reduced by choosing slower shutter speeds:

movie recording (P. 58), silent mode (P. 74), Pro Capture shooting (P. 74), High Res Shot (P. 76), focus bracketing (P. 134), focus stacking (P. 134)

Flicker can be reduced by choosing slower shutter speeds. You can also reduce flicker using flicker scan.  [📷 Flicker Scan] (P. 194),  [📷 Flicker Scan] (P. 148)

## Error codes

Monitor indication	Possible cause	Corrective action
 No Card	The card is not inserted, or it cannot be recognized.	Insert a card. Or reinsert the card properly.
 Card Error	There is a problem with the card.	Insert the card again. If the problem persists, format the card. If the card cannot be formatted, it cannot be used.
 Write Protect	Writing to the card is prohibited.	The card write-protect switch is set to the "LOCK" side. Release the switch (P. 211).
 Card Full	The card is full. No more pictures can be taken or no more information such as print reservation can be recorded. There is no space in the card and print reservation or new images cannot be recorded.	Replace the card or erase unwanted pictures. Before erasing, download important images to a PC.
 No Picture	There are no pictures on the card.	The card contains no pictures. Record pictures and play back.
 Picture Error	The selected picture cannot be displayed for playback due to a problem with this picture. Or the picture cannot be used for playback on this camera.	Use image processing software to view the picture on a PC. If that cannot be done, the image file is damaged.
 The Image Cannot Be Edited	Pictures taken with another camera cannot be edited on this camera.	Use image processing software to edit the picture.
Y/M/D	The clock is not set.	Set the clock (P. 27).

Monitor indication	Possible cause	Corrective action
	The internal temperature of the camera has risen due to sequential shooting.	Turn off the camera and wait for the internal temperature to cool.
 Internal camera temperature is too high. Please wait for cooling before camera use.		Wait a moment for the camera to turn off automatically. Allow the internal temperature of the camera to cool before resuming operations.
 Battery Empty	The battery is drained.	Charge the battery.
 No Connection	The camera is not correctly connected to a computer, HDMI display, or other device.	Reconnect the camera.
The lens is locked. Please extend the lens.	The lens of the retractable lens stays retracted.	Extend the lens.
Please check the status of a lens.	An abnormality has occurred between the camera and the lens.	Turn off the camera, check the connection with the lens, and turn the power on again.

## Default Settings

\*1: Can be added to [Assign to Custom Mode].

\*2: Default can be restored by selecting [Full] for [Reset].

\*3: Default can be restored by selecting [Basic] for [Reset].

### Live Controls/LV Super Control Panel

Shooting mode	Item	Default	*1	*2	*3	
P/A/S/M/B	ISO	Auto	✓	✓	✓	80
	Flash Mode		✓	✓	✓	94
		±0	✓	✓	✓	97
	Manual Value	FULL (flash set to [ MANUAL])	✓	✓	✓	95
	Image Stabilizer	S-IS AUTO	✓	✓	✓	86
	WB	Auto ([On] selected for [ AUTO Keep Warm Color])	✓	✓	✓	83
	WB compensation A	±0	✓	✓	—	85
	WB compensation G	±0	✓	✓	—	85
	Kelvin	5400K ([CWB] selected for [WB])	✓	✓	—	83
	AF Area	Center/single	✓	✓	✓	65
	AF Mode	S-AF	✓	✓	✓	80
	Face Priority	Face & Eye Priority On	✓	✓	—	67
			✓	✓	✓	87
	Metering		✓	✓	✓	82
		F (High Res Shot: F+RAW)	✓	✓	✓	88
			✓	✓	✓	89
	Picture Mode	Natural	✓	✓	✓	98
	Sharpness	±0	✓	✓	—	101
	Contrast	±0	✓	✓	—	101
	Saturation	±0	✓	✓	—	101
	Gradation	Gradation Normal	✓	✓	—	102
	Effect	— ([i-Enhance] selected for [Picture Mode]:  Standard)	✓	✓	—	104
	Color Filter	— ([Monochrome] selected for [Picture Mode]: N:None)	✓	✓	✓	103
	Monochrome Color	— ([Monochrome] selected for [Picture Mode]: N:Normal)	✓	✓	✓	104
	Aspect	4:3	✓	✓	✓	87
	Color Space	sRGB	✓	✓	✓	105
	Highlight&Shadow Control	(±0)	✓	✓	✓	106
	Movie	On	✓	✓	✓	150

Shooting mode	Item	Default	*1	*2	*3	
(movie)	ISO	[P], [A], or [S] selected for [ Mode]: Auto (fixed) [M] selected for [ Mode]: 200	✓	✓	✓	80
	Flash Mode	Flash Off (fixed)	—	—	—	—
		±0 (fixed)	—	—	—	—
	Image Stabilizer	M-IS	✓	✓	✓	86
	WB	Auto ([On] selected for [ Keep Warm Color])	✓	✓	✓	83
	WB compensation A	±0	✓	✓	—	85
	WB compensation G	±0	✓	✓	—	
	Kelvin	5400K ([CWB] selected for [WB])	✓	✓	—	83
	AF Area	Center; Small Target	✓	✓	✓	65
	AF Mode	C-AF	✓	✓	✓	80
	Face Priority	Face & Eye Priority On	✓	✓	—	67
	Metering	(fixed)	—	—	—	—
			✓	✓	✓	89
	Picture Mode	Natural	✓	✓	✓	98
	Sharpness	±0	✓	✓	—	101
	Contrast	±0	✓	✓	—	101
	Saturation	±0	✓	✓	—	101
	Gradation	Gradation Normal	✓	✓	—	102
	Aspect	16:9 (fixed) C4K selected for [ ]: 17:9	—	—	—	—
	Color Space	sRGB (fixed)	—	—	—	—
	Highlight&Shadow Control	(±0)	✓	✓	✓	106
	Mode	P	—	✓	—	147
	Movie	On	✓	✓	✓	150
RC mode	A group A	TTL	✓	✓	✓	216
	B group B	Off	✓	✓	✓	
	C group C	Off	✓	✓	✓	
	camera flash	Off	✓	✓	✓	
	Flash compensation	±0 (TTL, Auto)	✓	✓	✓	
	Flash level	1/1 (Manual)	✓	✓	✓	
	/FP	(Normal)	✓	✓	✓	
	optical signal strength	Low	✓	✓	✓	
	Channel	1	✓	✓	✓	

## Shooting Menu

Tab	Function	Default	*1	*2	*3	👉		
1	Reset / Custom Modes	Reset	—	—	✓	—	127, 128	
		Assign to Custom Mode	Shooting mode: P Image quality: L F+RAW					
		Recall from Custom Mode	—					
	Picture Mode	📷 Natural	✓	✓	✓	98, 129		
	📷👈	L F (High Res Shot: 📷 F+RAW)	✓	✓	✓	88, 129		
	Image Aspect	4:3	✓	✓	✓	87		
	Digital Tele-converter	Off	✓	✓	✓	130		
	📷/📷/📷		—	✓	✓	✓	71	
		📷/📷	<input type="checkbox"/>	✓	✓	✓		
		Intrvl. Sh./Time Lapse	Off	—	✓	✓	131	
		Number of Frames	99					
		Start Waiting Time	00:00:01					
		Interval Length	00:00:01					
		Time Lapse Movie	Off					
	Movie Settings	Movie Resolution FullHD						
		Frame Rate 10fps						
2	Bracketing		Off	✓	✓	✓	132, 133, 134	
		AE BKT	3f 1.0EV					
		WB BKT	A–B	Off				
			G–M					
		FL BKT	Off					
		ISO BKT	Off					
		ART BKT	Off					
		Focus BKT		Off				
			Focus Stacking	Off				
			Set number of shots	99				
			Set focus differential	5				
			⚡ Charge Time	0 sec	✓	✓		—
		HDR	Off	✓	✓	✓		137
	Multiple Exposure	Number of Frames	Off	—	✓	✓	139	
		Auto Gain	Off					
		Overlay	Off					
	Keystone Comp.	Off	✓	✓	✓	141		

Tab	Function		Default	*1	*2	*3	
	Anti-Shock []/ Silent []	Anti-Shock []	[] 0 sec	✓	✓	—	142
		Silent []	[] 0 sec				
		Noise Reduction []	Off				
		Silent [] Mode Settings	—	✓	✓	—	
			Not Allow				
		AF Illuminator	Not Allow				
	Flash Mode	Not Allow					
High Res Shot	High Res Shot	0 sec	✓	✓	—	143	
	Charge Time	0 sec					
RC Mode		Off	✓	✓	✓	143, 216	

## Video Menu

Tab	Function		Default	*1	*2	*3	
	Mode Settings	Mode	P	—	✓	—	147
		Flicker Scan	Off	✓	✓	✓	148
	Specification Settings		MOV  4K 30p	✓	✓	✓	149
		Noise Filter	Standard	✓	✓	✓	144
		Picture Mode	Off	✓	✓	—	144
	AF/IS Settings	AF Mode	C-AF	✓	✓	✓	80, 86, 144
		Image Stabilizer	M-IS	✓	✓	✓	
	Button/Dial/Lever						145
	Button Function	ISO Button Function	ISO	—	✓	—	
		Button Function		—	✓	—	
		Function	REC	—	✓	—	
		Function	AEL/AFL	—	✓	—	
		Button Function	Off	—	✓	—	
		Function		—	✓	—	
		Function		—	✓	—	
		Function	Direct Function	—	✓	—	
		Function	WB				
		Function	Electronic Zoom	—	✓	—	
	Function	AF Stop	—	✓	—		
	Dial Function	P	: :	—	✓	—	
		A	: : FNo.	—	✓	—	
S		: : Shutter	—	✓	—		
M		: FNo. : Shutter	—	✓	—		
Fn Lever Function		mode2	—	✓	—		
Shutter Function			—	✓	—		
Elec. Zoom Speed		Normal	—	✓	—		



Tab	Function		Default	*1	*2	*3	
	Display Settings						146
	Control Settings		Live Control, Live SCP	—	✓	—	
	Info Settings		Custom1 (all on except for Movie Effect)	—	✓	—	
	Time Code Settings	Time Code Mode	Drop Frame	—	✓	—	
		Count Up	Rec Run	—	✓	—	
		Starting Time	0:00:00	—	✓	—	
	Movie		On	✓	✓	✓	150
	Recording Volume	Built-in	±0	—	✓	—	
		MIC	±0	—	✓	—	
	Volume Limiter		On	—	✓	—	
Wind Noise Reduction		Off	—	✓	—		
Recording Rate		48kHz/16bit	—	✓	—		
Plug-in Power		On	—	✓	—		
PCM Recorder Link	Camera Rec. Volume	Operative	—	✓	—		
	Slate Tone	Off	✓	✓	—		
	Synchronized	Off	✓	✓	—		
HDMI Output	Output Mode	Monitor Mode	—	✓	—	146	
	REC Bit	Off	✓	✓	—		
	Time Code	On	✓	✓	—		

## Playback Menu

Tab	Function		Default	*1	*2	*3		
			On	✓	✓	✓	153	
	Edit	Sel. Image	RAW Data Edit	—	—	—	—	153
			JPEG Edit	—				154
			Movie Edit	—				156
				—				122
	Image Overlay		—	—	—	—	155	
	Print Order		—	—	—	—	120	
	Reset Protect		—	—	—	—	158	
	Reset share Order		—	—	—	—	158	
	Device Connection		—	—	—	—	201	

## ⌘ Setup Menu

Tab	Function	Default	*1	*2	*3	👉	
⌘	Card Setup	—	—	—	—	160	
		—	—	—	—	27	
		English	—	—	—	29, 159	
		±0, ±0, Natural	✓	✓	—	159	
	Rec View	0.5 sec	✓	✓	—	159	
	Wi-Fi/Bluetooth Settings	Availability	On	—	✓	—	207
		Connection Password	—	—	—	—	206
		Power-off Standby	Off	—	✓	—	202
		Reset Settings	—	—	—	—	206
Firmware	—	—	—	—	159		

## ⚙ Custom Menu

Tab	Function	Default	*1	*2	*3	👉		
⚙	AF/MF							
	A1	AF mode	S-AF	✓	✓	✓	80, 161	
		AEL/AFL	S-AF	mode1	✓	✓	✓	161, 175
			C-AF	mode2				
			MF	mode1				
		AF Scanner	mode2	✓	✓	✓	161	
		C-AF Sensitivity	±0	✓	✓	✓	176	
		C-AF Center Start	(All Targets)	✓	✓	✓	177	
	C-AF Center Priority	5, 9, or 25 targets	✓	✓	✓	178		
	A2	[::]Mode Settings	All On	✓	✓	✓	162	
		AF Area Pointer	On1	✓	✓	✓	162	
		AF Targeting Pad	Off	✓	✓	✓	162	
		[::] Set Home	AF Target Mode, AF Target Point	✓	✓	✓	162	
		[::] Custom Settings	Set 1	✓	✓	✓	162	
			[::]Mode	✓	✓	✓		
			☹	✓	✓	✓		
			⇄Pos	✓	✓	✓		
			⇄Pos	✓	✓	✓		
		A3	AF Limiter	Off	✓	✓	✓	163
	Distance settings		Setting 1	✓	✓	✓		
	Release Priority		On	✓	✓	✓		
	AF Illuminator		On	✓	✓	✓	163	
	Face Priority			✓	✓	—	67, 163	
	AF Focus Adj.*	Off	✓	✓	✓	163		

\* Using [Reset] to perform a full or standard reset does not affect saved values.

Tab	Function		Default	*1	*2	*3		
	A4	Preset MF distance	999.9 m	✓	✓	✓	163	
		MF Assist	Magnify	Off	✓	✓	—	163,
			Peaking	Off	✓	✓	—	180
		MF Clutch	Operative	✓	✓	✓	163	
		Focus Ring		✓	✓	✓		
		Bulb/Time Focusing	On	✓	✓	✓		
Reset Lens	On	✓	✓	✓				
Button/Dial/Lever								
B		ISO Button Function	ISO	✓	✓	—	107, 164	
		Button Function		✓	✓	—		
		Function	REC	✓	✓	—		
		Function	AEL/AFL	✓	✓	—		
		Button Function		✓	✓	—		
		Function		✓	✓	—		
		Function		✓	✓	—		
		Function		✓	✓	—		
		Function	Off ( )	✓	✓	—		
		Function	Off ()	✓	✓	—		
	Function	AF Stop	✓	✓	—			
	Function	<input checked="" type="checkbox"/>	✓	✓	—	164		
		Dial Function	P	: : Ps	✓	✓	—	164
A			: : FNo.					
S			: : Shutter					
M/B			: FNo. : Shutter					
Menu			 : <b>Value</b>					
			: Prev/Next 					
Dial Direction	Exposure	Dial1	✓	✓	—	164		
	Ps	Dial1						
	Fn Lever Function	mode2	—	✓	—	164, 181		
	Fn Lever/Power Lever	Fn	—	✓	—	164		
	Elec. Zoom Speed	Normal	✓	✓	—	164		

Tab	Function	Default	*1	*2	*3			
	Release/Image Stabilizer							
	<b>C1</b>	S-AF Release Priority	Off	✓	✓	✓	165	
		C-AF Release Priority	On	✓	✓	✓	165	
		L Settings					165, 182	
		/◆	Max fps	6fps	✓	✓	✓	
			Frame Count Limiter	Off				
		♥	Max fps	10fps				
			Frame Count Limiter	Off				
		Pro Cap	Pre-shutter Frames	8 shots				
			Frame Count Limiter	25 shots				
		H Settings					165, 182	
			Max fps	10fps	✓	✓	✓	
			Frame Count Limiter	Off				
		♥	Max fps	30fps				
			Frame Count Limiter	Off				
		Pro Cap	Max fps	30fps				
			Pre-shutter Frames	8 shots				
			Frame Count Limiter	25 shots				
		Flicker Reduction	Anti-Flicker LV	Auto	✓	✓	—	165, 184
			Anti-Flicker Shooting	Off	✓	✓	—	
<b>C2</b>	Image Stabilizer	S-IS AUTO	✓	✓	✓	86, 165		
	Image Stabilizer	Fps Priority	✓	✓	—	165		
	Half Way RIs With IS	On	—	✓	—	165		
	Lens I.S. Priority	Off	✓	✓	✓	165		

Tab	Function		Default	*1	*2	*3			
	Disp/■)/PC								
	D1	Control Settings		Live Guide	—	✓	—	166, 186	
			P/A/S/M/B	Live SCP	✓	✓	—		
			ART	Art Menu	—	✓	—		
			SCN	Scene Menu	—	✓	—		
		/Info Settings		Info	Image Only, Overall	✓	✓	✓	166, 188
				Info	All On	—	✓	—	
			LV-Info	Image Only, Custom1 (), Custom2 (Level Gauge)	✓	✓	—		
				Settings	25, Calendar	✓	✓	—	
	Picture Mode Settings			All On	✓	✓	—	166	
	/Settings			,  ,  Pro,  ,  ,  Pro,  ,  ,  ,	✓	✓	—	166	
	Multi Function Settings			All on except WB and ISO	✓	✓	—	166	
	D2	Live View Boost	Manual Shooting	Off	✓	✓	✓	167	
			Bulb/Time	On2					
			Live Composite	Off					
			Others	Off					
		Art LV Mode			mode1	✓	✓	—	167
		LV Close Up Settings	LV Close Up Mode		mode2	✓	✓	—	167
			Live View Boost		Off	✓	✓	—	
		Default Setting			Recently	—	✓	—	167
		Settings	Lock		Off	✓	✓	—	167
Live View Boost			Off	✓	✓	—			
D3	Grid Settings	Display Color	Preset 1	✓	✓	—	168		
		Displayed Grid	Off	✓	✓	—			
		Apply Settings to EVF	On	✓	✓	—			
	Peaking Settings	Peaking Color	Red	✓	✓	—	168		
		Highlight Intensity	Normal						
		Image Brightness Adj.	Off						
	Histogram Settings	Highlight	255	✓	✓	—	168		
		Shadow	0						
	Mode Guide			Off	✓	✓	—	168	
Selfie Assist			On	—	✓	—	168, 190		
D4			On	✓	✓	✓	168		
	HDMI	Output Size	1080p	—	✓	—	168, 191		
		HDMI Control	Off	—	✓	—			
		Output Frame Rate	60p Priority	—	—	—			
	USB Mode			Auto	—	✓	✓	168	

Tab	Function	Default	*1	*2	*3			
	Exp/ISO/BULB/							
	<b>E1</b> Exposure Shift		±0	✓	✓	—	169	
	EV Step		1/3EV	✓	✓	✓	169	
	ISO Step		1/3EV	✓	✓	✓	169	
	ISO-Auto Set	Upper Limit / Default	Upper Limit: 6400 Default: 200	✓	✓	✓	169	
		Lowest S/S Setting	Auto	✓	✓	✓		
	ISO-Auto		All	✓	✓	—	169	
	Noise Filter		Standard	✓	✓	✓	169	
	Noise Reduct.		Auto	✓	✓	✓	169	
	<b>E2</b>	Bulb/Time Timer		8 min	✓	✓	✓	170
		Bulb/Time Monitor		-7	✓	✓	—	170
		Live Bulb		Off	✓	✓	—	170, 192
		Live Time		0.5 sec	✓	✓	—	170, 192
		Composite Settings		1 sec	✓	✓	—	47, 170, 193
		Flicker Scan		Off	✓	✓	✓	170, 194
		<b>E3</b> Metering			✓	✓	✓	82, 170
	AEL Metering		Auto	✓	✓	✓	170	
	[:::] Spot Metering	Spot	On	✓	✓	✓	170	
		Spot Highlight	On	✓	✓	✓		
		Spot Shadow	On	✓	✓	✓		
	Custom							
<b>F</b>	X-Sync.		1/250	✓	✓	✓	170, 195	
	Slow Limit		1/60	✓	✓	✓	170, 195	
	+		Off	✓	✓	✓	170	
	+WB		WB AUTO	✓	✓	—	170	

Tab	Function		Default	*1	*2	*3		
	←WB/Color							
	<b>G</b>	← Set		←-1: <b>L</b> SF ←-2: <b>L</b> F ←-3: <b>L</b> N ←-4: <b>L</b> N	✓	✓	✓	171, 196
		Pixel Count	<b>M</b> iddle	3200×2400	✓	✓	✓	171, 196
			<b>S</b> mall	1280×960				
		Shading Comp.		Off	✓	✓	✓	171
		WB		Auto   A±0, G±0	✓	✓	✓	83, 171
		All <b>WB</b>	All Set	A±0, G±0	✓	✓	—	171
			All Reset	—	—	—	—	
	<b>WB</b> AUTO	Keep Warm Color		✓	✓	✓	171	
	Color Space		sRGB	✓	✓	✓	105, 171	
	Record/Erase							
	<b>H1</b>	File Name		Reset	✓	✓	—	172
		Edit Filename		—	✓	✓	—	172
dpi Settings		350dpi	✓	✓	—	172		
Copyright Settings		Copyright Info.		Off	✓	✓	—	172
		Artist Name		—	—	—		
		Copyright Name		—	—	—		
Lens Info Settings*		Off	—	✓	—	172, 196		
<b>H2</b>	Quick Erase		Off	✓	✓	✓	173	
	RAW+JPEG Erase		RAW+JPEG	✓	✓	✓	173	
	Priority Set		No	✓	✓	✓	173	
EVF								
<b>I</b>	EVF Auto Switch		On	—	✓	—	173	
	EVF Adjust	EVF Auto Luminance	Off	✓	✓	—	173	
		EVF Adjust	$\frac{1}{2}$ ±0, $\frac{1}{4}$ ±0					
	EVF Style		Style 3	—	✓	—	173, 197	
	Info Settings		Basic Information, Custom1 () Custom2 (Level Gauge)	✓	✓	—	173	
	EVF Grid Settings	Display Color	Preset 1	✓	✓	—	173	
		Displayed Grid	Off	✓	✓	—		
	Half Way Level		On	✓	✓	—	173	
S-OVF		Off	✓	✓	✓	173		

\* [Reset] (Full) and [Reset] (Basic) do not reset the info for individual lenses.

Tab	Function	Default	*1	*2	*3	
	Utility					
<b>11</b>	Pixel Mapping	—	—	—	—	174, 223
	Press-and-hold Time					174
	End LV	0.7 sec	✓	✓	—	
	Reset LV  Frame	0.7 sec	✓	✓	—	
	End	0.7 sec	✓	✓	—	
	Reset  Frame	0.7 sec	✓	✓	—	
	Reset	0.7 sec	✓	✓	—	
	Reset	0.7 sec	✓	✓	—	
	Reset	0.7 sec	✓	✓	—	
	Reset	0.7 sec	✓	✓	—	
	Reset	0.7 sec	✓	✓	—	
	Call EVF Auto Switch	0.7 sec	✓	✓	—	
	End	0.7 sec	✓	✓	—	
	Switch	0.7 sec	✓	✓	—	
	Insert Slate Tone	0.7 sec	✓	✓	—	
	End	0.7 sec	✓	✓	—	
	Reset	0.7 sec	✓	✓	—	
	Switch  Lock	0.7 sec	✓	✓	—	
	Call BKT Settings	0.7 sec	✓	✓	—	
	End Flicker Scan	0.7 sec	✓	✓	—	
	Level Adjust	—	—	✓	—	174
	Touchscreen Settings	On	—	✓	—	174
	Menu Recall	Recall	✓	✓	—	174
	Fisheye Compensation	Off	✓	✓	—	174, 198
<b>12</b>	Backlit LCD	Hold	✓	✓	✓	174
	Sleep	1 min	✓	✓	✓	174
	Auto Power Off	4h	✓	✓	✓	174
	Quick Sleep Mode	Off	✓	✓	—	174
	Backlit LCD	8 sec				
	Sleep	10 sec				
	Certification	—	—	—	—	174



## Record mode and file size/number of storable still pictures

### Memory Card Capacity: Photos

Figures are for an 16 GB SD card used to record photos with an aspect ratio of 4:3.

Record mode	Image size (Pixel Count)	Compression	File format	File size (MB)	Number of storable still pictures
50m F+RAW	10400×7792	Loss-less compression	ORF	125	87
	8160×6120	1/4	JPEG	21.7	
	5200×3904	Loss-less compression	ORI	21.5	
25m F+RAW	10400×7792	Loss-less compression	ORF	125	89
	5760×4320	1/4	JPEG	10.9	
	5200×3904	Loss-less compression	ORI	21.5	
50m F	8160×6120	1/4	JPEG	21.7	634
25m F	5760×4320	1/4	JPEG	10.9	1261
RAW	5240×3192	Loss-less compression	ORF	21.5	696
1 SF	5184×3888	1/2.7	JPEG	13.1	1054
1 F		1/4		8.9	1550
1 N		1/8		4.6	3013
1/2 SF	3200×2400	1/2.7		5.1	2697
1/2 F		1/4		3.6	3906
1/2 N		1/8		1.9	7397
1/4 SF	1920×1440	1/2.7		2	6975
1/4 F		1/4		1.4	9765
1/4 N		1/8		0.9	16836
1/8 SF	1280×960	1/2.7		1	13562
1/8 F		1/4		0.8	18083
1/8 N		1/8		0.5	28721
1/16 SF	1024×768	1/2.7		0.8	18779
1/16 F		1/4		0.6	24413
1/16 N		1/8		0.3	61032

- The number of storable still pictures may change according to the subject, whether or not print reservations have been made, and other factors. In certain instances, the number of storable still pictures displayed on the monitor will not change even when you take pictures or erase stored images.
- The actual file size varies according to the subject.
- The maximum number of storable still pictures displayed on the monitor is 9999.

## Memory Card Capacity: Movies

Figures are for a 32 GB SDHC memory card.



Frame size	Compression	Frame rate	Capacity (approx.)
C4K	—	24p	17 minutes
4K	—	30p, 25p, 24p	40 minutes
FHD	A-I	30p, 25p, 24p	20 minutes
	SF	60p, 50p, 30p, 25p, 24p	1 hour 16 minutes
	F		2 hours 7 minutes
	N		3 hours 22 minutes
HD	A-I	60p, 50p, 30p, 25p, 24p	40 minutes
	SF		2 hours 25 minutes
	F		4 hours 11 minutes
	N		5 hours 32 minutes

- Figures are for footage recorded at the maximum frame rate. The actual bit rate varies with the frame rate and scene recorded.
- Individual movie files can be up to 4 GB in size. A new file is created when the size of the current file reaches 4 GB.
- Individual movies can be no more than 29 minutes in length.

## Specifications

### ■ Camera

Product type	
Product type	Digital camera with interchangeable Micro Four Thirds Standard lens system
Lens	M.ZUIKO DIGITAL, Micro Four Thirds System Lens
Lens mount	Micro Four Thirds mount
Equivalent focal length on a 35 mm film camera	Approx. twice the focal length of the lens
Image pickup device	
Product type	4/3" Live MOS sensor
Total no. of pixels	Approx. 21.77 million pixels
No. of effective pixels	Approx. 20.37 million pixels
Screen size	17.4 mm (H) × 13.0 mm (V)
Aspect ratio	1.33 (4:3)
Viewfinder	
Type	Electronic viewfinder with eye sensor
No. of pixels	Approx. 2.36 million dots
Magnification	100%
Eye point	Approx. 27 mm (−1 m <sup>-1</sup> )
Live view	
Sensor	Uses Live MOS sensor
Magnification	100%
Monitor	
Product type	3.0" TFT color LCD, Vari-angle, touch screen
Total no. of pixels	Approx. 1.04 million dots (aspect ratio 3:2)
Shutter	
Product type	Computerized focal-plane shutter
Shutter speed	1/8000 - 60 sec., bulb photography, time photography
Auto focus	
Product type	Hi-Speed Imager AF
Focusing points	121 points
Selection of focusing point	Auto, Optional
Exposure control	
Metering system	TTL metering system (imager metering) Digital ESP metering/Center weighted averaging metering/Spot metering
Metered range	−2 to 20 EV (f/2.8, ISO 100 equivalent)
Shooting modes	<b>A</b> : AUTO; <b>P</b> : Program AE (program shift available); <b>A</b> : Aperture priority AE; <b>S</b> : Shutter-priority AE; <b>M</b> : Manual; <b>B</b> : Bulb (bulb, time, and composite); <b>C</b> : Custom Mode; <b>M</b> : Movie; <b>ART</b> : Art Filter; <b>SCN</b> : Scene mode
ISO sensitivity	LOW, 200 - 25600 (1/3, 1 EV step)
Exposure compensation	±5.0 EV (1/3, 1/2, 1 EV step)

<b>White balance</b>	
Product type	Image pickup device
Mode setting	Auto/Presets WB (7 settings)/Customized WB/One-touch WB (camera can store up to 4 settings)
<b>Recording</b>	
Memory	SD, SDHC and SDXC UHS-II compatible
Recording system	Digital recording, JPEG (DCF2.0), RAW Data
Applicable standards	Exif 2.3, Digital Print Order Format (DPOF)
Sound with still pictures	Wave format
Movie	MPEG-4 AVC/H.264
Audio	Stereo linear PCM, 16 bit; sampling frequency 48 kHz (wave format) Stereo linear PCM, 24 bit; sampling frequency 96 kHz (wave format)
<b>Playback</b>	
Display format	Single-frame playback/Close-up playback/Index display/Calendar display
<b>Drive</b>	
Drive mode	Single-frame shooting/Sequential shooting/Self-timer
Sequential shooting	Up to 10 fps (📷)  Up to 30 fps (📷)  
Self-timer	Operation time: 12 sec./2 sec./Customized
Energy saving function	Switch to sleep mode: 1 minute, Power OFF: 4 hours (This function can be customized.)
<b>Flash</b>	
Flash control mode	TTL-AUTO (TTL pre-flash mode)/MANUAL
X-Sync.	1/250 s or slower
<b>Wireless LAN</b>	
Compatible standard	IEEE 802.11b/g/n
<b>Bluetooth®</b>	
Compatible standard	Bluetooth Version 4.2 BLE
<b>External connector</b>	
Micro-USB connector/HDMI micro connector (type D)	
<b>Power supply</b>	
Battery	Lithium-ion Battery ×1
<b>Dimensions/weight</b>	
Dimensions	125.3 mm (W) × 85.2 mm (H) × 49.7 mm (D) (4.9" × 3.4" × 2.0") (excluding protrusions)
Weight	Approx. 414 g (0.9 lb.) (including battery and memory card)
<b>Operating environment</b>	
Temperature	-10 °C - 40 °C (14 °F - 104 °F) (operation)/ -20 °C - 60 °C (-4 °F - 140 °F) (storage)
Humidity	30% - 90% (operation)/10% - 90% (storage)
Water resistance	Type: IEC Standard publication 60529 IPX1 (applies if camera is used with Olympus water-resistant lens)

### ■ Flash

MODEL NO.	FL-LM3
Guide number	9.1 (ISO100•m) 12.7 (ISO200•m)
Firing angle	Covers the picture angle of a 12 mm lens (equivalent to 24 mm in 35 mm format)
Dimensions	Approx. 43.6 mm (W) × 49.4 mm (H) × 39 mm (D) (1.7" × 1.9" × 1.5")
Weight	Approx. 51 g (1.8 oz.)
Splash resistance	Type Equivalent to IEC Standard publication 60529 IPX1

### ■ Lithium-ion battery

MODEL NO.	BLS-50
Product type	Rechargeable Lithium ion battery
Nominal voltage	DC 7.2 V
Nominal capacity	1210 mAh
No. of charge and discharge times	Approx. 500 times (varies with usage conditions)
Ambient temperature	0 °C - 40 °C (32 °F - 104 °F) (charging)
Dimensions	Approx. 35.5 mm (W) × 12.8 mm (H) × 55 mm (D) (1.4" × 0.5" × 2.2")
Weight	Approx. 46 g (0.1 lb.)

### ■ Lithium-ion charger

MODEL NO.	BCS-5
Rated input	AC 100 V - 240 V (50/60 Hz)
Rated output	DC 8.35 V, 400 mA
Charging time	Approx. 3 hours 30 minutes (room temperature)
Ambient temperature	0 °C - 40 °C (32 °F - 104 °F) (operation)/ -20 °C - 60 °C (-4 °F - 140 °F) (storage)
Dimensions	Approx. 62 mm (W) × 38 mm (H) × 83 mm (D) (2.4" × 1.5" × 3.3")
Weight (without AC cable)	Approx. 70 g (0.15 lb.)

- The supplied power cable is for use exclusively with this camera. Do not use with other equipment. Do not use the camera with cables for other equipment.

- The appearance and specifications of this product are subject to change without notice or obligation on the part of the manufacturer.
- Visit the OLYMPUS website for the latest specifications.

The terms HDMI and HDMI High-Definition Multimedia Interface, and the HDMI Logo are trademarks or registered trademarks of HDMI Licensing Administrator, Inc. in the United States and other countries.

**HDMI**™  
HIGH-DEFINITION MULTIMEDIA INTERFACE

## SAFETY PRECAUTIONS



**CAUTION**  
RISK OF ELECTRIC SHOCK  
DO NOT OPEN



CAUTION: TO REDUCE THE RISK OF ELECTRICAL SHOCK, DO NOT REMOVE COVER (OR BACK). NO USER-SERVICEABLE PARTS INSIDE. REFER SERVICING TO QUALIFIED OLYMPUS SERVICE PERSONNEL.



An exclamation mark enclosed in a triangle alerts you to important operating and maintenance instructions in the documentation provided with the product.

**WARNING**

If the product is used without observing the information given under this symbol, serious injury or death may result.

**CAUTION**

If the product is used without observing the information given under this symbol, injury may result.

**NOTICE**

If the product is used without observing the information given under this symbol, damage to the equipment may result.

**WARNING!**

TO AVOID THE RISK OF FIRE OR ELECTRICAL SHOCK, NEVER DISASSEMBLE, EXPOSE THIS PRODUCT TO WATER OR OPERATE IN A HIGH HUMIDITY ENVIRONMENT.

## General Precautions

**Read All Instructions** — Before you use the product, read all operating instructions. Save all manuals and documentation for future reference.

**Power Source** — Connect this product only to the power source described on the product label.

**Foreign Objects** — To avoid personal injury, never insert a metal object into the product.

**Cleaning** — Always unplug this product from the wall outlet before cleaning. Use only a damp cloth for cleaning. Never use any type of liquid or aerosol cleaner, or any type of organic solvent to clean this product.

**Heat** — Never use or store this product near any heat source such as a radiator, heat register, stove, or any type of equipment or appliance that generates heat, including stereo amplifiers.

**Attachments** — For your safety, and to avoid damaging the product, use only accessories recommended by Olympus.

**Location** — To avoid damage to the product, mount the product securely on a stable tripod, stand, or bracket.

## WARNING

- Do not use the camera near flammable or explosive gases.
- Rest your eyes periodically when using the viewfinder.

Failure to observe this precaution could result in eyestrain, nausea, or sensations similar to motion sickness. The length and frequency of the required rest varies with the individual; use your own judgement. If you feel tired or unwell, avoid using the viewfinder and if necessary consult a physician.

- Do not use the flash and LED (including AF illuminator) on people (infants, small children, etc.) at close range.
  - You must be at least 1 m (3 ft.) away from the faces of your subjects. Firing the flash too close to the subject's eyes could cause a momentary loss of vision.
- Do not look at the sun or strong lights with the camera.

- **Keep young children, infants away from the camera.**
  - Always use and store the camera out of the reach of young children and infants to prevent the following dangerous situations which could cause serious injury:
    - Becoming entangled in the camera strap, causing strangulation.
    - Accidentally swallowing the battery, cards or other small parts.
    - Accidentally firing the flash into their own eyes or those of another child.
    - Accidentally being injured by the moving parts of the camera.
- **Should you notice that the charger is emitting smoke, heat, or an unusual noise or smell, immediately cease use and unplug the charger from the power outlet, and then contact an authorized distributor or service center.**
- **Stop using the camera immediately if you notice any unusual odors, noise, or smoke around it.**
  - Never remove the batteries with bare hands, which may cause a fire or burn your hands.
- Never hold or operate the camera with wet hands.  
This may cause overheating, exploding, burning, electrical shocks, or malfunctions.
- **Do not leave the camera in places where it may be subject to extremely high temperatures.**
  - Doing so may cause parts to deteriorate and, in some circumstances, cause the camera to catch fire. Do not use the charger if it is covered (such as a blanket). This could cause overheating, resulting in fire.
- **Handle the camera with care to avoid getting a low temperature burn.**
  - When the camera contains metal parts, overheating can result in a low-temperature burn. Pay attention to the following:
    - When used for a long period, the camera will get hot. If you hold on to the camera in this state, a low-temperature burn may be caused.
    - In places subject to extremely cold temperatures, the temperature of the camera's body may be lower than the environmental temperature. If possible, wear gloves when handling the camera in cold temperatures.
- To protect the high-precision technology contained in this product, never leave the camera in the places listed below, no matter if in use or storage:
  - Places where temperatures and/or humidity are high or go through extreme changes. Direct sunlight, beaches, locked cars, or near other heat sources (stove, radiator, etc.) or humidifiers.
  - In sandy or dusty environments.
  - Near flammable items or explosives.
  - In wet places, such as bathrooms or in the rain.
    - In places prone to strong vibrations.
  - The camera uses a lithium-ion battery specified by Olympus. Charge the battery with the specified charger. Do not use any other chargers.
  - Never incinerate or heat batteries in microwaves, on hot plates, or in pressure vessels, etc.
  - Never leave the camera on or near electromagnetic devices.  
This may cause overheating, burning, or exploding.
  - Do not connect terminals with any metallic objects.
  - Take precautions when carrying or storing batteries to prevent them from coming into contact with any metal objects such as jewelry, pins, fasteners, keys, etc.  
The short circuit may cause overheating, exploding, or burning, which burn or damage you.
  - To prevent causing battery leaks or damaging their terminals, carefully follow all instructions regarding the use of batteries. Never attempt to disassemble a battery or modify it in any way, solder, etc.
  - If battery fluid gets into your eyes, flush your eyes immediately with clear, cold running water and seek medical attention immediately.
  - If you cannot remove the battery from the camera, contact an authorized distributor or service center. Do not try to remove the battery by force.  
Damage to the battery exterior (scratches, etc.) may produce heat or an explosion.
  - Always store batteries out of the reach of small children and pets. If they accidentally swallow a battery, seek medical attention immediately.
  - To prevent batteries from leaking, overheating, or causing a fire or explosion, use only batteries recommended for use with this product.
  - If rechargeable batteries have not been recharged within the specified time, stop charging them and do not use them.
  - Do not use batteries with scratches or damage to the casing, and do not scratch the battery.

- Never subject batteries to strong shocks or continuous vibration by dropping or hitting. This may cause exploding, overheating, or burning.
- If a battery leaks, has unusual odor, becomes discolored or deformed, or becomes abnormal in any other way during operation, stop using the camera, and keep away from fire immediately.
- If a battery leaks fluid onto your clothing or skin, remove the clothing and flush the affected area with clean, running cold water immediately. If the fluid burns your skin, seek medical attention immediately.
- Never use lithium-ion batteries in a low-temperature environment. Doing so may cause generation of heat, ignition, or explosion.
- The Olympus lithium-ion battery is designed to be used only for the Olympus digital camera. Do not use the battery to other devices.
- **Do not allow children or animals/pets to handle or transport batteries (prevent dangerous behaviour such as licking, putting in mouth or chewing).**

## Use Only Dedicated Rechargeable Battery and Battery Charger

We strongly recommend that you use only the genuine Olympus dedicated rechargeable battery and battery charger with this camera.

Using a non-genuine rechargeable battery and/or battery charger may result in fire or personal injury due to leakage, heating, ignition or damage to the battery. Olympus does not assume any liability for accidents or damage that may result from the use of a battery and/or battery charger that are not genuine Olympus accessories.

### CAUTION

- **Do not cover the flash with a hand while firing.**
- Never store batteries where they will be exposed to direct sunlight, or subjected to high temperatures in a hot vehicle, near a heat source, etc.
- Keep batteries dry at all times.
- The battery may become hot during prolonged use. To avoid minor burns, do not remove it immediately after using the camera.
- This camera uses one Olympus lithium-ion battery. Use the specified genuine battery. There is a risk of explosion if the battery is replaced with the incorrect battery type.
- Please recycle batteries to help save our planet's resources. When you throw away dead batteries, be sure to cover their terminals and always observe local laws and regulations.

### NOTICE

- **Do not use or store the camera in dusty or humid places.**
- **Use SD/SDHC/SDXC memory cards only. Never use other types of cards.** If you accidentally insert another type of card into the camera, contact an authorized distributor or service center. Do not try to remove the card by force.
- Regularly back up important data to a computer or other storage device to prevent accidental loss.
- OLYMPUS accepts no liability for any loss of data associated with this device.
- Be careful with the strap when you carry the camera. It could easily catch on stray objects and cause serious damage.
- Before transporting the camera, remove a tripod and all other non-OLYMPUS accessories.
- Never drop the camera or subject it to severe shocks or vibrations.
- When attaching the camera to or removing it from a tripod, rotate the tripod screw, not the camera.
- Do not touch electric contacts on cameras.
- Do not leave the camera pointed directly at the sun. This may cause lens or shutter curtain damage, color failure, ghosting on the image pickup device, or may possibly cause fires.
- Do not leave the viewfinder exposed to a strong light source or direct sunlight. The heat may damage the viewfinder.
- Do not push or pull severely on the lens.
- Be sure to remove any water droplets or other moisture from the product before replacing the battery or opening or closing covers.
- Before storing the camera for a long period, remove the batteries. Select a cool, dry location for storage to prevent condensation or mold from forming inside the camera. After storage, test the camera by turning it on and pressing the shutter button to make sure that it is operating normally.
- The camera may malfunction if it is used in a location where it is subject to a magnetic/ electromagnetic field, radio waves, or high voltage, such as near a TV set, microwave, video game, loud speakers, large monitor unit, TV/radio tower, or transmission towers. In such cases, turn the camera off and on again before further operation.
- Always observe the operating environment restrictions described in the camera's manual.



- Insert the battery carefully as described in the operating instructions.
- Before loading, always inspect the battery carefully for leaks, discoloration, warping, or any other abnormality.
- Always unload the battery from the camera before storing the camera for a long period.
- When storing the battery for a long period, select a cool location for storage.
- Power consumption by the camera varies depending on which functions are used.
- During the conditions described below, power is consumed continuously and the battery becomes exhausted quickly.
  - The zoom is used repeatedly.
  - The shutter button is pressed halfway repeatedly in shooting mode, activating the auto focus.
  - A picture is displayed on the monitor for an extended period of time.
- Using an exhausted battery may cause the camera to turn off without displaying the battery level warning.
- If the battery's terminals get wet or greasy, camera contact failure may result. Wipe the battery well with a dry cloth before use.
- Always charge a battery when using it for the first time, or if it has not been used for a long period.
- When operating the camera with battery power at low temperatures, try to keep the camera and spare battery as warm as possible. A battery that has run down at low temperatures may be restored after it is warmed at room temperature.
- Before going on a long trip, and especially before traveling abroad, purchase extra batteries. A recommended battery may be difficult to obtain while traveling.

## Using the wireless LAN/ Bluetooth® functions

- **Turn off the camera in hospitals and other locations where medical equipment is present.**  
The radio waves from the camera may adversely affect medical equipment, causing a malfunction that results in an accident. Be sure to disable wireless LAN/**Bluetooth**® functions in the vicinity of medical equipment (P. 207).
- **Turn off the camera when onboard aircraft.**  
Using wireless devices onboard may hinder safe operation of the aircraft. Be sure to disable wireless LAN/**Bluetooth**® functions onboard aircraft (P. 207).

## Monitor

- Do not push the monitor forcibly; otherwise the image may become vague, resulting in a playback mode failure or damage to the monitor.
- A strip of light may appear on the top/bottom of the monitor, but this is not a malfunction.
- When a subject is viewed diagonally in the camera, the edges may appear zigzagged on the monitor. This is not a malfunction; it will be less noticeable in playback mode.
- In places subject to low temperatures, the monitor may take a long time to turn on or its color may change temporarily.  
When using the camera in extremely cold places, it is a good idea to occasionally place it in a warm place. The monitor exhibiting poor performance due to low temperatures will recover in normal temperatures.
- The monitor of this product is manufactured with high-quality accuracy, however, there may be a stuck or dead pixel on the monitor. These pixels do not have any influence on the image to be saved. Because of the characteristics, the unevenness of the color or brightness may also be found depending on the angle, but this is due to the structure of the monitor. This is not a malfunction.

## Legal and Other Notices

- Olympus makes no representations or warranties regarding any damages, or benefit expected by using this unit lawfully, or any request from a third person, which are caused by the inappropriate use of this product.
- Olympus makes no representations or warranties regarding any damages or any benefit expected by using this unit lawfully which are caused by erasing picture data.

## Disclaimer of Warranty

- Olympus makes no representations or warranties, either expressed or implied, by or concerning any content of these written materials or software, and in no event shall be liable for any implied warranty of merchantability or fitness for any particular purpose or for any consequential, incidental or indirect damages (including but not limited to damages for loss of business profits, business interruption and loss of business information) arising from the use or inability to use these written materials or software or equipment. Some countries do not allow the exclusion or limitation of liability for consequential or incidental damages or of the implied warranty, so the above limitations may not apply to you.
- Olympus reserves all rights to this manual.

## Warning

Unauthorized photographing or use of copyrighted material may violate applicable copyright laws. Olympus assumes no responsibility for unauthorized photographing, use or other acts that infringe upon the rights of copyright owners.

## Copyright Notice

All rights reserved. No part of these written materials or this software may be reproduced or used in any form or by any means, electronic or mechanical, including photocopying and recording or the use of any type of information storage and retrieval system, without the prior written permission of Olympus. No liability is assumed with respect to the use of the information contained in these written materials or software, or for damages resulting from the use of the information contained therein. Olympus reserves the right to alter the features and contents of this publication or software without obligation or advance notice.

## Trademarks

- Microsoft and Windows are registered trademarks of Microsoft Corporation.
- Mac, OS X, and macOS are trademarks of Apple Inc.
- SDXC Logo is a trademark of SD-3C, LLC.
- Apical logo is a registered trademark of Apical Limited.
- Micro Four Thirds, Four Thirds, and the Micro Four Thirds and Four Thirds logos are trademarks or registered trademarks of the OLYMPUS CORPORATION in Japan, the United States, the countries of the European Union, and other countries.
- Wi-Fi is a registered trademark of the Wi-Fi Alliance.
- The Wi-Fi CERTIFIED logo is a certification mark of the Wi-Fi Alliance.
- The **Bluetooth**® word mark and logos are registered trademarks owned by the Bluetooth SIG, Inc. and any use of such marks by OLYMPUS CORPORATION is under license.



- The standards for camera file systems referred to in this manual are the "Design Rule for Camera File System/DCF" standards stipulated by the Japan Electronics and Information Technology Industries Association (JEITA).
- All other company and product names are registered trademarks and/or trademarks of their respective owners.

THIS PRODUCT IS LICENSED UNDER THE AVC PATENT PORTFOLIO LICENSE FOR THE PERSONAL AND NONCOMMERCIAL USE OF A CONSUMER TO (i) ENCODE VIDEO IN COMPLIANCE WITH THE AVC STANDARD ("AVC VIDEO") AND/OR (ii) DECODE AVC VIDEO THAT WAS ENCODED BY A CONSUMER ENGAGED IN A PERSONAL AND NON-COMMERCIAL ACTIVITY AND/OR WAS OBTAINED FROM A VIDEO PROVIDER LICENSED TO PROVIDE AVC VIDEO. NO LICENSE IS GRANTED OR SHALL BE IMPLIED FOR ANY OTHER USE. ADDITIONAL INFORMATION MAY BE OBTAINED FROM MPEG LA, L.L.C. SEE [HTTP://WWW.MPEGLA.COM](http://WWW.MPEGLA.COM)

The software in this camera may include third party software. Any third party software is subject to the terms and conditions, imposed by the owners or licensors of that software, under which software is provided to you.

Those terms and other third party software notices, if any, may be found in the software notice PDF file stored at <http://www.olympus.co.jp/en/support/imsg/digicamera/download/notice/notice.cfm>

The following functions are added/modified by firmware update.

## Additions/modifications by the firmware version 1.1



EVF Auto Switch

251

## Additions/modifications by the firmware version 1.1

### EVF Auto Switch

The Custom Menu (**MENU** → \* → → [EVF Auto Switch]) now offers a choice of [On1] and [On2].

Option	Description
<b>EVF Auto Switch</b>	<p>[Off]: The viewfinder display does not light automatically when you put your eye to the viewfinder. Press the  button to switch between the viewfinder and monitor displays.</p> <p>[On1]: The viewfinder display lights automatically when you put your eye to the viewfinder. Pressing the  button displays [EVF Auto Switch] options.</p> <p>[On2]: Putting your eye to the viewfinder turns the viewfinder display on only if the monitor is closed. Pressing the  button displays [EVF Auto Switch] options.</p>

### Default settings

The default settings for new functions and the modified default settings are as follows.

\*1: Can be added to [Assign to Custom Mode].

\*2: Default can be restored by selecting [Full] for [Reset].

\*3: Default can be restored by selecting [Basic] for [Reset].

### \* Custom Menu

Tab	Function	Default	*1	*2	*3	
	EVF Auto Switch	On1	—	✓	—	173

## Symbols

	(Protect) .....	118
	(Beep sound) .....	168
	Mode (movie exposure mode) .....	147
	(Trimming) .....	154
	Function .....	164
	Default Setting .....	189
	RC Mode .....	216
	Slow Limit .....	195
	X-Sync .....	195
	+WB .....	170
	(Index display/Calendar display) .....	117
	/Info Settings .....	188
	Settings .....	166
	H Settings .....	165, 182
	L Settings .....	165, 182
	Image Stabilizer .....	165
	(Monitor brightness adjustment) .....	159
	(Underwater wide/Underwater macro) .....	109
	(Single-frame erase) .....	119
	Mode Settings .....	162
	Custom Settings .....	162
	Set Home .....	162, 179
	Spot Metering .....	170
	(Language) .....	29, 159
	(Image selection) .....	119
	(Face priority AF) .....	67
	(Close-up playback) .....	117
	(Image rotation) .....	153
	Half Way Level .....	173
	Info Settings .....	173
	Keep Warm Color .....	84, 171
	WB .....	170
	Settings .....	167

## A

<b>A</b> (Aperture priority mode) .....	39
Accessories .....	214, 219
AdobeRGB .....	105
AEL/AFL .....	175

AEL Metering .....	170
AE lock .....	70, 175
AF Area Pointer .....	162
AF Focus Adj. ....	163
AF Illuminator .....	163
AF Limiter .....	163
AF Mode .....	80
Movie .....	144
AF Scanner .....	161
AF Targeting Pad .....	162
AF Target Point .....	66
AF tracking .....	81
All <b>WBZ</b> .....	171
Anti-Flicker LV .....	165, 184
Anti-Flicker Shooting .....	165, 185
Anti-shock shooting .....	73, 142
<b>ART</b> (Art filter) .....	55
Art fade .....	59
Art filter .....	55
Art LV Mode .....	167
Aspect ratio .....	87
Assign to Custom Mode .....	128
Audio recording .....	
Movie .....	150, 151
Still image .....	122
AUTO mode ( <b>AUTO</b> ) .....	49
Auto Power Off .....	174
Available recording time .....	242

## B

Backlight HDR .....	53
Backlit LCD .....	174
Battery charge .....	18
Battery level .....	26
Beep sound .....	168
Bit rate .....	90, 149
<b>Bluetooth</b> ® .....	200
Bracketing .....	132
Bulb .....	45
Bulb/Time Focusing .....	163, 180
Bulb/Time Monitor .....	170

Bulb/Time Timer .....	170
Button function.....	107
Movie .....	145

## C

C-AF <b>TR</b> (AF tracking) .....	81
C-AF Center Priority .....	161, 178
C-AF Center Start.....	161, 177
C-AF (Continuous AF).....	80
C-AF Release Priority.....	165
C-AF Sensitivity.....	161, 176
Calendar display.....	117, 189
Card.....	21, 211
Card Setup .....	160
Certification.....	174
Close-up playback.....	117
Color Creator .....	100
Color Filter.....	103
Color Space.....	105, 171
Composite Settings .....	47, 193
Compression rate .....	90, 196, 241
Computer.....	208
Connection	
Computer .....	208
Smartphone .....	200
Continuous AF .....	80
Contrast.....	101
Control Settings	
Movie .....	146
Still image .....	166, 186
Copyright Settings .....	172
Custom Menu .....	161, 234
Custom Self-timer.....	73
Custom Settings .....	162

## D

Date/time setting (⌚).....	27
Dial Direction .....	164
Dial Function	
Movie .....	145
Still image .....	164
Digital Tele-converter.....	130
dpi Settings.....	172
DPOF.....	120

## E

Edit .....	153
Edit Filename.....	172
Effect (i-Enhance).....	104
Electronic Zoom.....	112
Elec. Zoom Speed	
Movie .....	145
Still image .....	164
Erase	
All images .....	160
Selected images .....	119
Single-frame .....	119
EVF Adjust.....	173
EVF Auto Switch.....	173
EVF Grid Settings.....	173
EVF Style.....	197
EV Step .....	169
Exif data.....	172
Exposure compensation .....	64
Exposure Shift .....	169
External flash units .....	215
Eye priority AF .....	67

## F

Face priority AF .....	67
Fast-motion movie .....	92
File format.....	241
File Name .....	172
File size .....	241
Firmware.....	159
Fisheye Compensation .....	198
Flash .....	93
Flash intensity control (⚡).....	97
Flicker Reduction.....	165, 184
Flicker Scan	
Movie .....	148
Still image .....	194
Fn Lever Function	
Movie .....	145
Still image .....	164, 181
Fn Lever/Power Lever .....	164
Focus mode.....	80
Focus Ring .....	163

Format .....	160
Frame Rate.....	90, 149

## G

GPS log .....	205
Gradation.....	102
Grid Settings.....	168
Grip.....	214

## H

Half Way RIs With IS .....	165
HDMI .....	168, 191
HDMI Output.....	146
HDR (High Dynamic Range) .....	137
Highlight&Shadow Control.....	106
High Res Shot (High resolution shooting) 76, 143	
Histogram display .....	33
Histogram Settings .....	168

## I

IC recorder.....	151
Image aspect.....	87
Image Overlay .....	155
Image quality	
Movie (📹 ⏪).....	89, 149
Still image (📷 ⏪).....	88, 129
Image quality settings	
Movie (📹 Specification Settings)...	144
Still image (📷 Set).....	171, 196
Image size	
Movie .....	149
Still image .....	88, 196, 241
Image Stabilizer.....	86, 165
Movie .....	86, 144
Image transfer to smartphone .....	203
Index display.....	117, 189
<b>INFO</b> button.....	33, 115, 186
Information display .....	30
Playback .....	114
Info Settings	
📷/Info Settings.....	188
📷 Info Settings .....	173
In-Movie Image Capture .....	156

Installation .....	209
Interchangeable lenses .....	212
ISO-Auto.....	169
ISO-Auto Set .....	169
ISO sensitivity.....	70, 80
ISO Step .....	169

## K

Keystone Comp. ....	141
---------------------	-----

## L

Language setting (🌐).....	29, 159
Lens Info Settings.....	196
Lens I.S. Priority .....	165
Level Adjust .....	174
Level Gauge .....	33
Lever function .....	181
Light box display.....	188
Live Bulb.....	45, 192
Live composite photography.....	47
Live control .....	187, 229
Live Guide .....	49
Live Time .....	45, 192
Live View Boost.....	167
Long exposure (BULB/TIME) .....	45
LV Close Up Settings.....	167
LV-Info .....	189
LV super control panel.....	77, 79, 229

## M

<b>M</b> (Manual mode).....	43
Manual focus .....	80
Manual focus clutch (MF clutch).....	213
Menu.....	125, 229
Menu Recall.....	174
Metering.....	82
MF (AF/MF toggle).....	109
MF Assist.....	180
MF Clutch .....	213
MF (Manual focus).....	80
Mode Guide.....	168
Monochrome Color .....	104
Movie 🎥.....	150
Movie Effect.....	59

Movie exposure mode .....	147
Movie playback .....	118
Movie recording .....	58, 59
Movie Tele-converter .....	59
Movie Trimming .....	157
Multi echo .....	59
Multi Function .....	113
Multi Function Settings .....	166
Multiple Exposure .....	139

## N

Noise Filter .....	169
Noise Reduct .....	169
Number of storable still pictures .....	241

## O

Ol.Share .....	200
Old film .....	59
Olympus Workspace .....	209
On-board charging .....	19
One shot echo .....	59
One-touch white balance (☑) .....	84, 108

## P

<b>P</b> (Program mode) .....	37
PC software .....	209
Peaking .....	110, 180
Peaking Settings .....	168
Picture Mode .....	98, 129
Picture Mode Settings .....	166
Pixel Count .....	171, 196, 241
Pixel Mapping .....	223
Playback	
Movie .....	116, 118
Still image .....	116
Playback Menu .....	153, 233
Position information .....	205
PreMF (Preset MF) .....	81
Preset MF .....	81
Preset MF distance .....	163
Press-and-hold Time .....	174
Preview .....	108
Priority Set .....	173
Pro Capture shooting .....	74

Program shift ( <b>Ps</b> ) .....	38
Protect .....	118
<b>Ps</b> (Program shift) .....	38

## Q

Quick Erase .....	173
Quick Sleep Mode .....	174

## R

RAW Data Edit .....	153
RAW image .....	88
RAW+JPEG Erase .....	173
RC Mode (⚡RC Mode) .....	216
Rec View .....	159
Remote shooting .....	204
Reset .....	127
Reset Lens .....	163
Reset Protect .....	158
Reset share Order .....	158
Rotate .....	117

## S

<b>S</b> (Shutter priority mode) .....	41
S-AF <b>MF</b> (Single AF and Manual focus) ..	80
S-AF Release Priority .....	165
S-AF (Single AF) .....	80
Saturation .....	101
Scene mode .....	50
<b>SCN</b> mode .....	50
SD card .....	211
Formatting the card .....	160
Selfie Assist .....	190
Self-timer .....	71, 73, 87
Sequential shooting .....	71, 87
Setup Menu .....	159, 234
Shading Comp .....	171
Share Order .....	119
Sharpness .....	101
Shooting	
Movie .....	59
Still image .....	34
Shooting Menu .....	127, 231
Shooting modes .....	34

Silent shooting .....	74, 142
Single AF .....	80
Sleep .....	26
Slow motion movie .....	92
S-OVF.....	173
sRGB.....	105
Storage.....	208
Super control panel .....	77, 79, 229
Super Spot AF .....	68



## T

---

Test Picture.....	109
Time.....	45
Time Code Settings .....	146
Time Lapse Movie .....	131
Time lapse shooting .....	131
Touch AF.....	36
Touch screen operations .....	36, 123
Touchscreen Settings .....	174
TV .....	191

## U

---

Underwater wide/Underwater macro (  /  )	109
USB connection.....	208
USB Mode .....	168
User registration .....	9

## V

---

Video Menu .....	144, 232
------------------	----------

## W

---

WB.....	83, 171
White balance.....	83, 171
White balance compensation .....	85
Wi-Fi/Bluetooth Settings .....	160
Wireless LAN.....	200
Wireless remote control flash .....	216

## Z

---

Zoom frame AF.....	68
--------------------	----



**OLYMPUS KOREA CO., LTD.**

2F-3F Majestar City 1, 12, Seocho-daero 38-gil, Seocho-gu, Seoul,  
06655, Republic of Korea  
Tel. 1544-3200  
E-mail: [hotline.okr@olympus-ap.com](mailto:hotline.okr@olympus-ap.com)  
<http://www.olympus.co.kr>

**OLYMPUS (MALAYSIA) Sdn Bhd**

512, 5th Floor, Block D, Kelana Square 17, Jalan SS 7/26, Kelana Jaya,  
47301 Petaling Jaya, Selangor, Malaysia  
Tel: (603) 7806 2173  
Fax: (603) 7803 7164  
E-mail: [service.oml@olympus-ap.com](mailto:service.oml@olympus-ap.com)  
<http://www.olympus.com.my>

**OLYMPUS (Thailand) CO., LTD.**

23/112 Sorachai Building, 27th Floor, Soi Sukhumvit 63 (Ekamai)  
Sukhumvit road Klongton Nua, Wattana, Bangkok 10110 Thailand  
Tel: (66) 2-000-7700  
E-mail: [imaging.oth@olympus-ap.com](mailto:imaging.oth@olympus-ap.com)

## **OLYMPUS AMERICA INC.**

3500 Corporate Parkway, P.O. Box 610, Center Valley, PA 18034-0610, U.S.A. Tel. 484-896-5000

### **Technical Support (U.S.A. / Canada)**

24/7 online automated help:

<http://www.olympusamerica.com/support>

Phone customer support:

Tel. 1-800-260-1625 (Toll-free)

Our phone customer support is available from 9 am to 9 pm (Monday to Friday) ET

<http://olympusamerica.com/contactus>

Olympus software updates can be obtained at:

<http://www.olympusamerica.com/digital>

## **OLYMPUS EUROPA SE & CO. KG**

Premises: Consumer Product Division  
Wendenstrasse 14-18, 20097  
Hamburg, Germany

Tel: +49 40-23 77 3-0 / Fax: +49 40-23 07 61

Goods delivery: Modul H, Willi-Bleicher Str. 36,  
52353 Düren, Germany

Mailing address: Postfach 10 49 08,  
20034 Hamburg, Germany

### **European Technical Customer Support:**

Please visit our homepage <http://www.olympus-europa.com> or call our TOLL FREE NUMBER\* :  
**00800 - 67 10 83 00**

for Austria, Belgium, Denmark, Finland, France, Germany, Luxemburg, Netherlands, Norway,  
Poland, Portugal, Spain, Sweden, Switzerland, United Kingdom.

810-800 67 10 83 00 for Russia

800 167 777 for Czech Republic

\* Please note some phone service providers do not permit access to 00800 numbers or require an additional prefix. Charges may apply here. Please contact your service provider directly for more details.

For all not listed European Countries and in case that you can't get connected to the above mentioned number, please make use of the following CHARGED NUMBERS **+49 40 - 237 73 899**

## **OLYMPUS (BEIJING) SALES & SERVICE CO.,LTD**

Customer Support: 400-650-0303 Homepage: <http://olympus-imaging.cn>

### **Customer Service Center:**

10F, K, Wah Centre, 1010 Huaihai Road(M), Xuhui District, Shanghai

Zip: 200031

## **OLYMPUS HONG KONG AND CHINA LIMITED**

Digital Camera Repair Centre

L4207, Office Tower, Langham Place, 8 Argyle Street, Mongkok, Kowloon, Hong Kong

Customer Hotline: +852-2376-2150 Fax: +852-2375-0630

E-mail: [cs.ohc@olympus-ap.com](mailto:cs.ohc@olympus-ap.com)

<http://www.olympus.com.hk>